

DSO4000 Series
Digital Storage Oscilloscope
User Manual

(Version 1.3)

Contents

Contents	i
Safety Tips	1
General Safety Summary	1
Safety Terms and Symbols	2
Product Scrapping	2
Brief Introduction to DSO4000 Series	3
Chapter 1 Introduction	4
1.1 Accident of front panel and the user interface	1
1.1.1 Front Panel	1
1.1.2 User Interface	2
1.2 Functional Check.....	3
1.2.1 Power on the oscilloscope	3
1.2.2 Connect the oscilloscope	3
1.2.3 Observe the waveform.....	4
1.3 Probe Examination	4
1.3.1 Safety	4
1.3.2 Use of Probe Check Wizard	5
1.3.3 Manual Probe Compensation	5
1.3.4 Probe Attenuation Setting	6
1.4 Self Calibration	6
Chapter 2 Main Feature Description	7
2.1 Menu and control keys	7
2.2 Multi-functional Knobs and Buttons.....	8
2.3 Signal Connectors	8
2.4 Oscilloscope Setup.....	9
2.5 Default setups	9
2.6 Horizontal System	11
2.6.1 Horizontal control knob	12
2.6.2 Display Scan mode.....	14
2.7 Vertical System.....	15
2.7.1 Vertical Controls.....	15
2.7.2 Math FFT	16
2.8 Trigger System	22
2.8.1 Trigger Controls	23
2.9 Save/Recall	29
2.10 Display System.....	31
2.10.1 XY Format.....	32
2.11 Measure System	32

2.11.1	Scale measurement.....	32
2.11.2	Cursor measurement.....	32
2.11.3	Measurement.....	35
2.12	Acquisition System.....	37
2.13	UTILITY System.....	39
2.13.1	Firmware Update.....	39
2.13.2	Self Calibration.....	40
2.13.3	Keypad Beep Control.....	40
2.13.4	Language.....	40
2.13.5	GUI Color Setting.....	40
2.13.6	Time Setting.....	40
2.13.7	System Status.....	40
2.13.8	Pass/fail.....	40
2.13.9	Recorder.....	42
2.13.10	Filter.....	43
2.13.11	Wave.....	44
2.13.12	DDS.....	44
2.13.13	DVM.....	44
2.14	Help System.....	45
2.15	Fast Action Buttons.....	46
2.15.1	Autoset.....	46
2.16	Waveform Generator.....	48
2.16.1	Set Wave Type and Parameters.....	48
2.16.2	Edit Arbitrary Waveform.....	48
2.16.3	Output Arbitrary Waveform.....	50
2.17	Power Amplifier(Optional).....	51
Chapter 3	Application Examples.....	52
3.1	Example 1: Taking Simple Measurements.....	53
3.2	Example 2: Taking Cursor Measurements.....	54
3.3	Example 3: Analyzing Input Signals to Eliminate Random Noise.....	57
3.4	Example 4: Capturing Single-shot Signal.....	59
3.5	Example 5: Using X-Y Mode.....	59
3.6	Example 6: Triggering on Pulse Width.....	61
3.7	Example 7: Triggering on Video Signal.....	62
3.8	Example 8: Using Slope Trigger to Capture Particular Slope Signal.....	63
3.9	Example 9: Using Overtime Trigger to Measure Long Pulse Signal.....	64
3.10	Example 10: Using Math Functions to Analyze Waveforms.....	65
3.11	Example 11: Measuring Data Propagation Delay.....	66
Chapter 4	Troubleshooting.....	68
4.1	Problem Settlement.....	68
Chapter 5	Specifications.....	69
5.1	Technical Specifications.....	69

5.2	Accessories	75
5.3	Open Source Information	75
	License: GPLv2 See Appendix B	75
Chapter 6	General Care and Cleaning	76
6.1	General Care	76
6.2	Cleaning	76
Appendix A	Harmful and Poisonous Substances or Elements	77
Appendix B	78
GNU GENERAL PUBLIC LICENSE	78
Version 2, June 1991	78

Safety Tips

General Safety Summary

Read the following safety precautions to avoid injury and prevent damage to this product or any products connected to it. To evade potential hazards, use this product only as specified.

Only qualified personnel should perform maintenance.

Avoid fire or personal injury.

Use suitable power cord. Use only the power cord specified for this product and certified for the country of use.

Connect and disconnect properly. Connect a probe with the oscilloscope before it is connected to measured circuits; disconnect the probe from the oscilloscope after it is disconnected from measured circuits.

Ground the product. This product is grounded through the grounding conductor of the power cord. To avoid electric shock, the grounding conductor must be connected to earth ground. Before making connections to the input or output terminals of the product, ensure that the product is properly grounded.

Connect the probe in a right way. The probe ground lead is at ground potential. Do not connect the ground lead to an elevated voltage.

Check all terminal ratings. To avoid fire or shock hazard, check all ratings and markings on the product. Refer to the product manual for detailed information about ratings before making connections to the product.

Do not operate without covers. Do not operate this product with covers or panels removed.

Avoid exposed circuitry. Do not touch exposed connections and components when power is present.

Do not operate with suspected failures. If you suspect there is damage to this product, have it inspected by qualified service personnel.

Assure good ventilation.

Do not operate in wet/damp environments.

Do not operate in an explosive atmosphere.

Keep product surfaces clean and dry.

Safety Terms and Symbols

Terms on Product

The following terms may appear on the product:

DANGER indicates an injury hazard immediately accessible as you read the marking.

WARNING indicates an injury hazard not immediately accessible as you read the marking.

CAUTION indicates a possible hazard to this product or other property.

Symbols on Product

The following symbols may appear on the product:

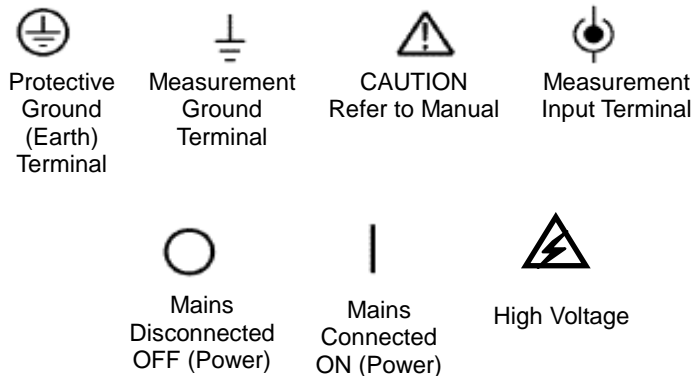

Product Scrapping

Device Recycling

We need extract and utilize natural resources to produce this device. If you do not reclaim the device in a proper way, some substances it contains may become harmful or poisonous to environments or human bodies. To avoid them being released outside and to minimize the waste of natural resources, we suggest you reasonably call back this device to ensure proper recovery and recycling of most materials within it.

Brief Introduction to DSO4000 Series

DSO4000 Series oscilloscopes cover the bandwidths from 70MHz to 200MHz, and provide the real-time and equivalent sample rates respectively up to 1GSa/s and 25GSa/s. In addition, they have 7 inch color TFT LCD as well as WINDOWS-style interfaces and menus for easy operation.

What's more, the plenty menu information and the easy-to-operate buttons allow you to gain information as much as possible in measurement; the multifunctional knobs and the powerful shortcut keys help you save a lot of time in operation; the Autoset function lets you detect sine and square waves automatically; the Probe Check Wizard guides you to adjust the probe compensation and set the Probe option attenuation factor. By using the three methods the oscilloscope provides (context-sensitive, hyperlinks, and an index), you may master all operations on the device in quite a short time so as to greatly improve your efficiency in production and development.

Model	Channels	Bandwidth	Sample Rate	LCD
DSO4072	2	70MHz	1GS/s	7 inch color
DSO4102	2	100MHz	1GS/s	7 inch color
DSO4202	2	200MHz	1GS/s	7 inch color

Model List of DSO4000 Series

Chapter 1 Introduction

- ◆ **Accidence of front panel and the user interface**
- ◆ **Functional Check**
- ◆ **Probe Examination**
- ◆ **Self Calibration**

1.1 Accidence of front panel and the user interface

This section will make you understand the front operation panel of this series of digital oscilloscope at first before use.

1.1.1 Front Panel

The content below simply describes and introduces the front panel and the back part of this series of digital oscilloscope so that you can get familiar with this series of digital oscilloscope well within the shortest time.

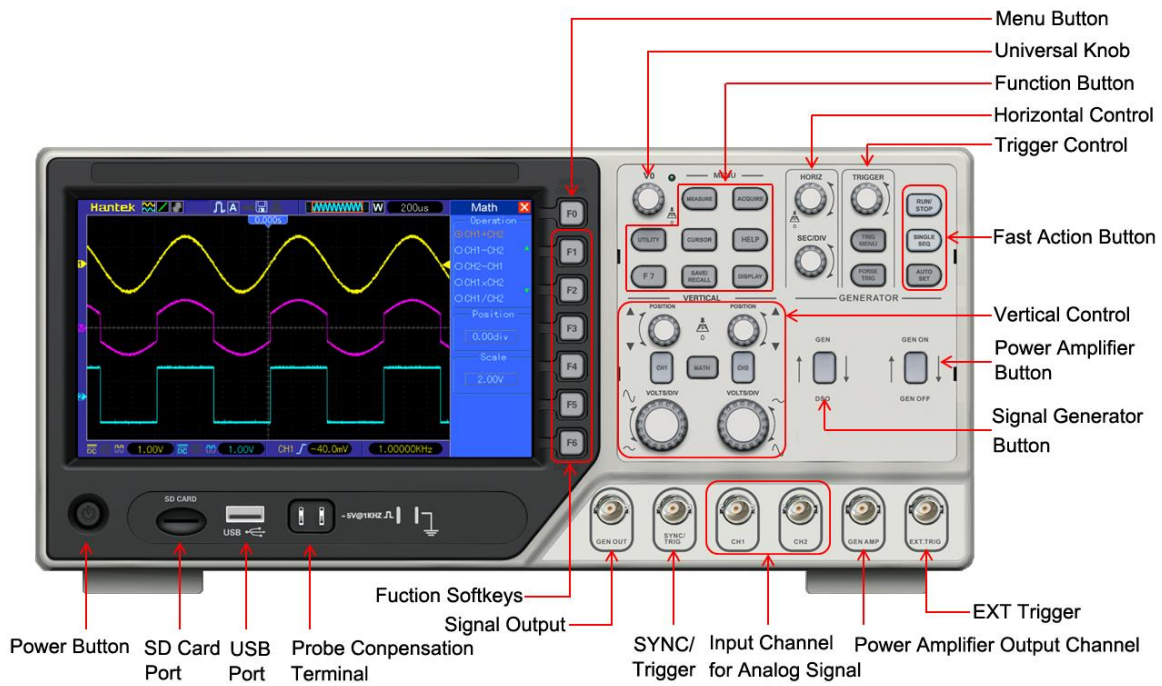
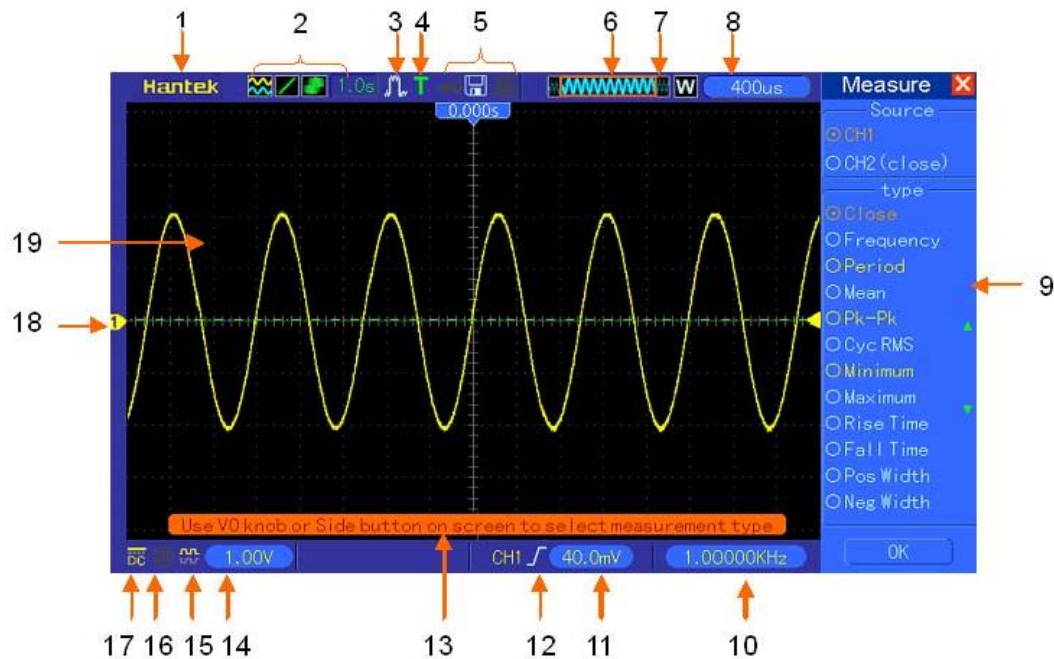

Figure 1-1 Figure of Front Panel

1.1.2 User Interface



1. Hantek mark

2. Display Format:



: Y-T



: X-Y



: Vectors



: Dots



: Gray indicates auto persistence; Green means persistence display is enabled. When the icon is set to green, the time for persistence display will be shown behind it.

3. Acquisition Mode: Normal, Peak Detect or Average

4. Trigger Status:



The oscilloscope is acquiring pretriggered data.



All pretriggered data have been acquired and the oscilloscope is ready to accept a trigger.



The oscilloscope has detected a trigger and is acquiring the posttrigger information.



The oscilloscope works in auto mode and is acquiring waveforms in the absence of triggers.



The oscilloscope is acquiring and displaying waveform data continuously in scan mode.

- The oscilloscope has stopped acquiring waveform data.

- The oscilloscope has finished a single sequence acquisition.

5. Tool Icon:



: If this icon lights up, it means the keyboard of the oscilloscope is locked by the host computer via USB control.





: If this icon lights up, it means the USB disk has been connected.



This icon lights up only when the USB slave interface is connected with the computer.

6. Main Time Base Window
7. Display of window's position in data memory and data length.
8. Window Time Base
9. Operating Menu shows different information for different function keys.
10. Readout shows frequency count.
11. Readout points out horizontal waveform position
12. Trigger Type:

 : Edge trigger on the rising edge.

 : Edge trigger on the falling edge.

 : Video trigger with line synchronization.

 : Video trigger with field synchronization.

 : Pulse Width trigger, positive polarity.

 : Pulse Width trigger, negative polarity.

13. Pop-up Prompt
14. Readout tells trigger level.
15. Icon indicates whether the waveform is inverted or not.
16. 20M Bandwidth Limit. If this icon lights up, it means the bandwidth limit is enabled, otherwise disabled.
17. Icon indicates channel coupling.
18. Channel Marker
19. Window displays waveform.

1.2 Functional Check

Follow the steps below to perform a quick functional check to your oscilloscope.

1.2.1 Power on the oscilloscope

Plug in the oscilloscope and press the ON/OFF button. Then push the "SAVE/RECALL ->F4" button to recover DEFAULT setting. The default Probe option attenuation setting is 10X.

1.2.2 Connect the oscilloscope

Set the switch on the probe to 10X and connect the probe to Channel 1 on the oscilloscope. First,

align the slot in the probe connector with the protuberance on the CH1 BNC and push to connect; then, turn to right to lock the probe in place; after that, connect the probe tip and reference lead to the PROBE COMP connectors. There is a mark on the panel: Probe COMP ~5V@1KHz.



1.2.3 Observe the waveform

Press the AUTOSET button and you should see within a few seconds a square wave of about 5V peak-to-peak at 1kHz in the display. Press the CH1 MENU button twice to remove Channel 1. Push the CH2 MENU button and repeat Step 2 and Step 3 to observe Channel 2.

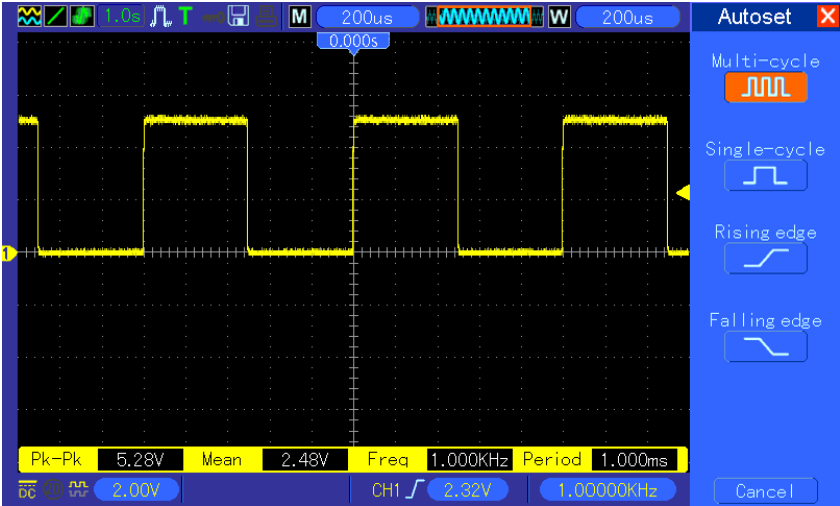

1.3 Probe Examination

1.3.1 Safety

When using the probe, keep your fingers behind the guard on the probe body to avoid electric shock. Do not touch metallic portions of the probe head while it is connected to a voltage source. Connect the probe to the oscilloscope and connect the ground terminal to ground before you start any measurements.

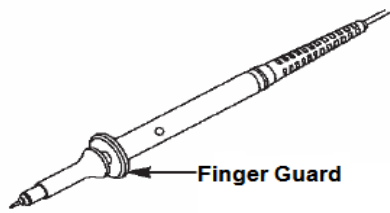

1.3.2 Use of Probe Check Wizard

Every time you connect a probe to an input channel, you should use the probe check wizard to verify that this probe is operating correctly.

Use the vertical menu (for example, push the CH1 MENU button) to set the Probe option attenuation factor.

1.3.3 Manual Probe Compensation

Upon the first connection of a probe and an input channel, you should manually perform this adjustment to match the probe to the input channel. Uncompensated or miscompensated probes may lead to errors or faults in measurement. To adjust the probe compensation, follow the steps below.

1. Set the Probe option attenuation in the channel menu to 10X. Set the switch on the probe to 10X and connect the probe to Channel 1 on the oscilloscope. If you use the probe hook-tip, ensure it is firmly inserted onto the probe. Attach the probe tip to the PROBE COMP ~5V@1KHz connector and the reference lead to the PROBE COMP Ground connector. Display the channel and then press the AUTOSSET button.
2. Check the shape of the displayed waveform.

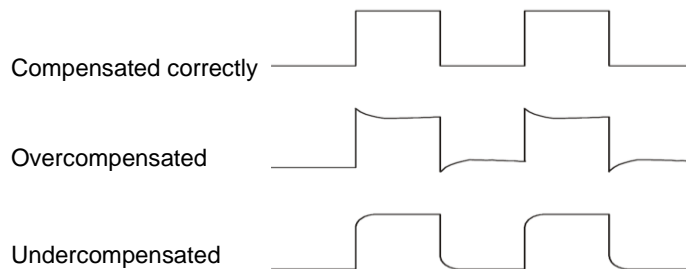

3. If necessary, use a nonmetallic screwdriver to adjust the variable capacity of your probe until the shape of the waveform turns to be the same as the above figure. Repeat this step as necessary. See the figure below for the way of adjustment.

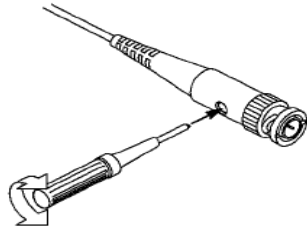

1.3.4 Probe Attenuation Setting

Probes are of various attenuation factors which affect the vertical scale of the signal. The Probe Check function is used to verify if the Probe attenuation option matches the attenuation of the probe.

As an alternative method to Probe Check, you can push a vertical menu button (such as the CH 1 MENU button) and select the Probe option that matches the attenuation factor of your probe.

Make sure that the Attenuation switch on the probe matches the Probe option in the oscilloscope. Switch settings are 1X and 10X.

When the Attenuation switch is set to 1X, the probe limits the bandwidth of the oscilloscope to 6MHz. To use the full bandwidth of the oscilloscope, be sure to set the switch to 10X.

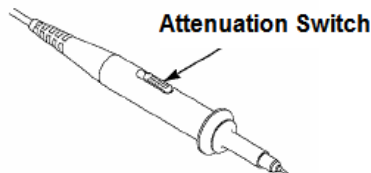

1.4 Self Calibration

The self calibration routine helps optimize the oscilloscope signal path for maximum measurement accuracy. You can run the routine at any time but should always run it if the ambient temperature changes by 5°C or more. For a more accurate calibration, please power on the oscilloscope and wait for 20 minutes until it has adequately warmed up.

To compensate the signal path, disconnect any probes or cables from the front-panel input connectors. Then, push the UTILITY button, select the Do Self Cal option and follow the directions on the screen.

Chapter 2 Main Feature Description

This chapter provides some general information that you need to learn before using an oscilloscope. It contains:

- [Menu and Control Keys](#)
- [Multi-functional Knobs and Buttons](#)
- [Signal Connectors](#)
- [Oscilloscope Setup](#)
- [Default Setups](#)
- [Default Setups](#)
- [Horizontal System](#)
- [Vertical System](#)
- [Trigger System](#)
- [Save and Recal](#)
- [Display System](#)
- [Measure System](#)
- [Acquisition System](#)
- [Utility System](#)
- [Help System](#)
- [Fast Action Buttons](#)
- [Waveform Generator](#)
- [Power Amplifier](#)(optional)

2.1 Menu and control keys

As shown in the figure below:

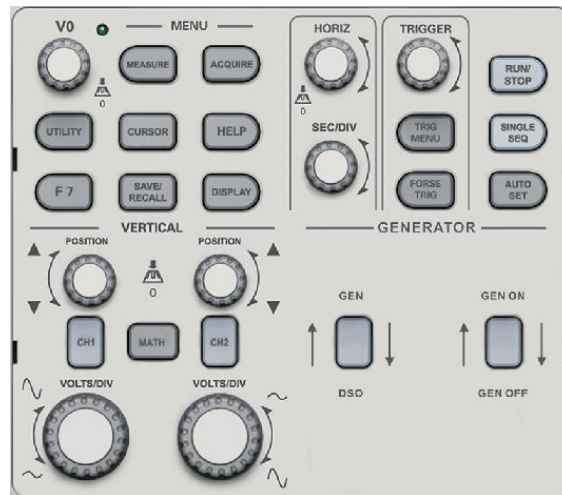
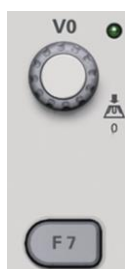

Figure2-1 Control keys

All the keys are described as follows:

- **[CH1], [CH2]:** display setup menus of channel 1 and channel 2.
- **[MATH]:** display “ARITHMETICAL OPERATION” and “REFERENCE WAVEFORM” menu.
- **[HORIZ]:** display “HORIZONTAL” menu.
- **[TRIG]:** display “TRIGGER” control menu.
- **[FORCE TRIG]:** It is used for finishing acquisition of the current waveform no matter whether the oscilloscope detects trigger, and it is mainly applied to “NORMAL” and “SINGLE” in the trigger mode.
- **[SAVE/RECALL]:** display the “SAVE/RECALL” menu of setups and waveform.
- **[MEASURE]:** display the “MEASURE” menu.
- **[ACQUIRE]:** display the “ACQUIRE” menu.
- **[UTILITY]:** display “UTILITY FUNCTION” menu.
- **[CURSOR]:** display the “CURSOR” menu. The [V0] knob can be used for regulating the position of the cursor when the “CURSOR” menu is displayed and the cursor is triggered.
- **[DISPLAY]:** show the “DISPLAY” menu.
- **[HELP]:** enter the on-line help system.
- **[AUTOSET]:** automatically set the control state of the oscilloscope so as to display suitable waveform.
- **[RUN/STOP]:** continuously acquire waveform or stop acquisition
- **[SINGLE SEQ]:** Acquire a single trigger, finish acquisition and then stop.
- **[GEN DSO]:** Waveform generator output button..
- **[GEN ON/GEN OFF]:** Power Amplifier output button.

2.2 Multi-functional Knobs and Buttons



V0: Multi-functional knob. Under different menu options, it supports selecting menu options (MEASURE), moving cursors and levels (Slope Trigger).

Press this knob to reset data (trigger holdoff, overtime of the overtime trigger and slope trigger), select menu options and so on. Easy to operate.

F7: Push this button in single-window mode to switch between dotted line display and cross display. Push it in dual-window mode to perform autocruise.



F0: **Hide/Show** button. Push it to hide the menu options on the right side of the screen and give a full screen display of waveforms. Push it again to show the menu options.

F1-F5: These five buttons are all multi-functional. They are in charge of selecting corresponding menu options on the screen in different menu modes. For example, in the UTILITY menu, F1-F5 respectively correspond to 'System Info' – 'Advance'.

F6: This functional button is mainly used to turn pages and confirm a selection, such as 'next page', 'previous page', and 'press F6 to confirm' appearing when you push Self Calibration option.

2.3 Signal Connectors

See the figure below to find the seven signals connectors and a pair of metal electrodes at the bottom of the oscilloscope panel.



1. GEN OUT: Waveform Signal Output.

2. SYNC/TRIG: Output the **Sync** signal, or input trigger signal on DDS interface.
3. CH1, CH2: Input connectors for waveform display, through which to connect and input the signal to be measured.
4. GEN AMP: Power amplifier output.
5. EXT.TRIG: Input connector for an external trigger source, though with to connect and input the external trigger signal.
6. Probe Compensation: Voltage probe compensation output and ground, used to electrically match the probe to the oscilloscope input circuit. The probe compensation ground and BNC shields connect to earth ground and are considered to be ground terminals. To avoid damages, do not connect a voltage source to any of these ground terminals.

2.4 Oscilloscope Setup

While operating the oscilloscope, you may often use three features: Autoset, saving a setup and recalling a setup. Hereinafter they are introduced one by one.

Autoset: This function can be used to adjust the horizontal and vertical scales of the oscilloscope automatically and set the trigger coupling, type, position, slope, level and mode, etc., to acquire a stable waveform display.

Saving a Setup: By default, the oscilloscope will save the setup each time before being closed, and automatically recall the setup once being turned on. (**Note: If you modify the setup, please wait for more than 5 seconds before turning off the oscilloscope to ensure the proper storage of new settings.**) You can save 10 settings permanently in the oscilloscope and reset them as necessary.

Recalling a Setup: The oscilloscope can recall any of your saved setups or the default factory setup.

Default Setup: The oscilloscope is preset for normal operations when it is shipped from the factory. This is the default setup. You may recall this setup at any time for your requirements.

2.5 Default setups

The default setups represent some option parameters that are set before the oscilloscope leaves factory for normal operations.

When you push “UTILITY->Default” button, the oscilloscope will display the CH1 waveform and remove all the others. The table below gives the options, buttons and controls that change settings at default setup.

Menu or System	Option, Button or Knob	Default Setting
Acquire	(Three mode options)	Normal
	Averages	16
	Run/Stop	Run

Cursor	Type	Off
	Source	CH1
	Horizontal (amplitude)	$\pm 3.2\text{div}$
	Vertical (time)	$\pm 4\text{div}$
Display	Type	Vectors
	Persist	Off
	Format	YT
Horizontal	Window Mode	Single-window
	Trigger Knob	Level
	Position	0.00s
	SEC/DIV	200 μs
Math	Operation	—
	Source	CH1-CH2
	Position	0div
FFT	Vertical Scale	20dB
	FFT Operation	
	Source	CH1
	Window	Hanning
	FFT Zoom	X1
Measure	Source	CH1
	Type	None
Trigger (Edge)	Type	Edge
	Source	CH1
	Slope	Rising
	Mode	Auto
	Coupling	DC
	Level	0.00v
Trigger (Video)	Polarity	Normal
	Sync	All lines
	Standard	NTSC
Trigger (Pulse)	When	=
	Set Pulse Width	1.00ms
	Polarity	Positive
	Mode	Auto
	Coupling	DC
Trigger (Slope)	Slope	Rising
	Mode	Auto
	Coupling	DC
	When	=
Trigger (Swap)	CH1	
	Type	Edge
	Slope	Rising
	Mode	Auto

	Coupling	DC
	Level	0.00v
	CH2	
	Type	Edge
	Slope	Rising
	Mode	Auto
	Coupling	DC
	Level	0.00v
Trigger (OT)	Source	CH1
	Polarity	Positive
	Mode	Auto
	Time	20ns
Vertical System, All Channels	Coupling	DC
	Bandwidth Limit	Unlimited
	VOLTS/DIV	Coarse
	Probe	Voltage
	Voltage Probe Attenuation	10X
	Invert	Off
	Position	0.00div (0.00V)
	VOLTS/DIV	1.00V

The following settings do not change when you push the DEFAULT SETUP button.

- Language Option
- Saved Settings
- Saved Reference Waveforms
- Display Contrast
- Calibration Data

2.6 Horizontal System

Use the horizontal controls to change the horizontal scale and position of waveforms. The horizontal position readout shows the time represented by the center of the screen, using the trigger time as zero. When you change the horizontal scale, the waveform will expand or contract to the screen center. The readout near the upper right of the screen shows the current horizontal position in second. W indicates 'Window Time Base'. The oscilloscope also has an arrow icon at the top of the graticule to indicate the horizontal position.

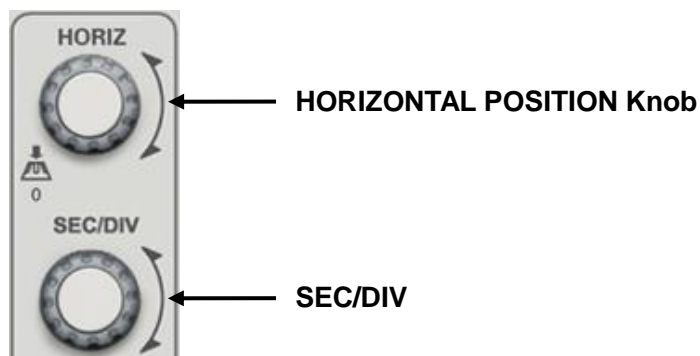

2.6.1 Horizontal control knob

The horizontal knob [SEC/DIV] changes the horizontal scale (time base), and the [POSITION] knob changes the horizontal position (triggered displacement) triggered in the internal memory. The center of the screen in the horizontal direction is a time reference point of the waveform. Change of the horizontal scale will cause expansion or contraction of the waveform relative to the center of the screen, while the change of the horizontal position is relative to the position of a trigger point.

Horizontal POSITION knob

1. Regulate the horizontal position (trigger the position relative to the center of the display screen) of the waveform (including MATH). The resolution of this control knob is changed according to the time base.
2. Use the press down function of this knob to make the horizontal displacement return to zero, namely back to the central position of the screen.

[SEC/DIV] knob

1. The knob is used for changing the horizontal time scale so as to conveniently observe the most suitable waveform.
2. The knob is used for regulating the main time base. When the window expansion mode is adopted, the knob is used for changing the expansion time base so as to change the window width.

Each option in **HORIZ MENU** is described as follows.

Press [**SEC/DIV**] key to display the horizontal menu “HORI MENU”, and window expansion can be implemented at this menu.

Options	Settings	Comments
Window Control	Major Window Minor Window	Selects the major or minor window in dual-window mode. The window is highlighted once selected. Press this option button in single-window mode to enter the dual-window mode.
Mark	Right arrow Left arrow Set/Clear Clear All	This function is usable only in dual-window mode. It sets marks at some waveform record locations that users are interested in, and searches for these marks by right and left arrows. Then it positions the window to this mark for further observation.

Page2/2

Holdoff	None	Select this menu and turn the multi-functional knob to adjust the trigger holdoff time within the range of 100ns-10s. Select this menu and push the multi-functional knob to reset the holdoff time with the starting value 100ns.
Autoplay	None	This function is usable in dual-window mode. Push this menu button and auto move it from left to right at a specified speed. In the expanded window will display corresponding waveforms until it stops once reaching the rightmost side of the major scan window.
Time/Div	Coarse Fine	
Horiz Position	Coarse Fine	

Window expansion

Window expansion is used for amplifying a segment of waveform so as to check details. The window expansion time base setup cannot be slower than the setup of the main time base. In the window expansion region, a selection region can be moved leftwards and rightwards by the horizontal [POSITION] knob or enlarged and reduced by revolving the [SEC/DIV] knob. The window expansion time base has higher resolution relative to the main time base. The smaller the window expansion time base is, the higher the horizontal expansion multiple of the waveform is.

Carry out the following steps to observe details of local waveform:

1. Press [HORI MENU] to display the "HORIZON" menu.
2. Press "Window Ctr" menu.
3. Revolve [SEC/DIV] (to regulate the size of the window) and the horizontal [POSITION] (to regulate the position of the window) to select the window of the waveform to be observed. The expansion time base cannot be slower than the main time base.

Press the "Minor Window" button after the window is setting well.

Single-window Mode

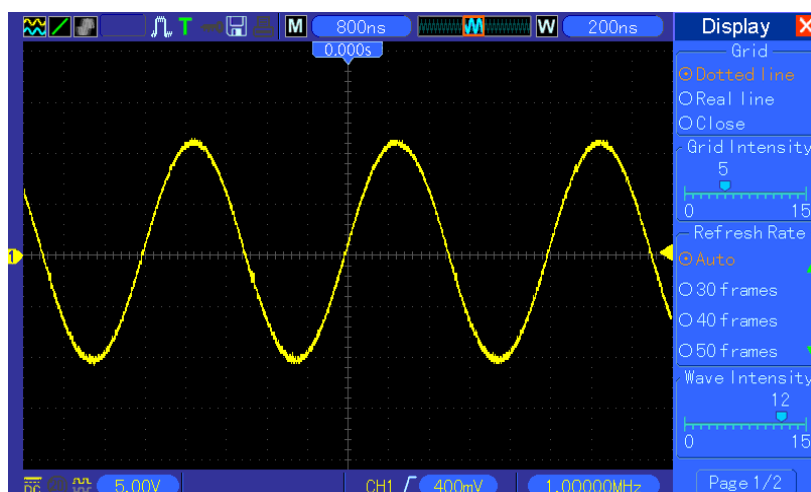

Dual-window Mode (Full Screen)

Location of expanded window data in memory

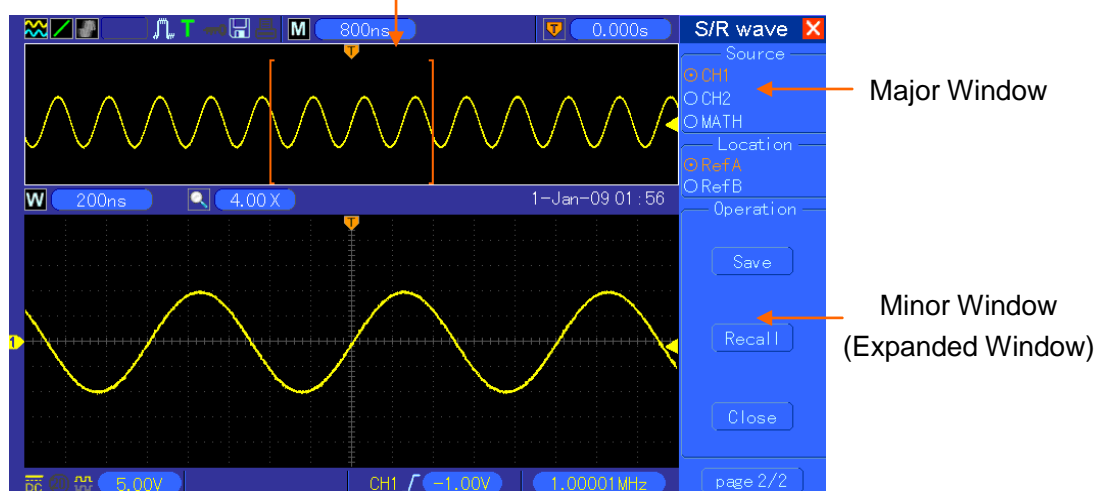

Notes:

1. For more information of the trigger holdoff, see [Trigger Controls](#).
2. In single-window mode, press F0 to hide or show the menus on the right side. The dual-window mode does not support the menu hiding function.

2.6.2 Display Scan mode

When the time base is set to be 80ms/div or more slowly and the trigger mode is set to “Auto”, the oscilloscope enters the scan mode. At this mode, waveform display is renewed from left to right. At the mode, no waveform trigger or horizontal position control exist. The channel coupling should be set as direct current when a low-frequency signal is observed at the scan mode.

2.7 Vertical System

2.7.1 Vertical Controls

Vertical controls can be used to display and remove waveforms, adjust vertical scale and position, set input parameters and perform math calculations. Each channel has a separate vertical menu to set. See below for menu description.

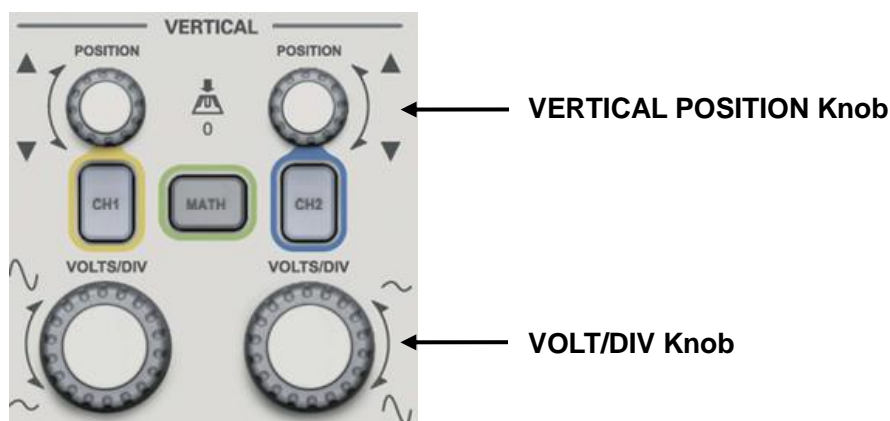

1. VERTICAL POSITION Knob

Move the channel waveform up and down on the screen. In dual-window mode, move the waveforms in both windows at the same time in a same direction. Push this knob to return waveforms to the vertical center position on the screen. Two channels correspond to two knobs.

2. VOLT/DIV Knob

Control the oscilloscope to magnify or attenuate the source signal of the channel waveform. The vertical size of the display on the screen will change (increase or decrease) to the ground level. Also you may use this knob to switch between coarse and fine.

3. **Menu (CH1, CH2):** Display vertical menu options; turn on or off the display of channel waveforms.

Options	Settings	Comments
Coupling	DC AC Ground	DC passes both DC and AC components of the input signal. AC blocks the DC component of the input signal and attenuates signals below 10Hz. Ground disconnects the input signal.
20MHz Bandwidth Limit	Unlimited Limited	Limits the bandwidth to reduce display noise; filters the signal to eliminate noise and other unnecessary HF components.
VOLTS/DIV	Coarse Fine	Selects the resolution of the VOLTS/DIV knob. Coarse defines a 1-2-5 sequence. Fine changes the resolution to small steps between the Coarse settings.

Probe Attenuation	1X 10X 100X 1000X	Selects a value according to the probe attenuation factor so as to ensure correct vertical readouts. Reduce bandwidth to 6MHz when using a 1X probe.
Invert	Off On	Inverts the waveform relative to the reference level.

Coupling

- If the channel adopts a DC coupling mode, you can quickly measure the DC component of the signal by observing the difference between the waveform and the signal ground.
- If the channel adopts an AC coupling mode, the DC component in the signal is filtered. By this mode, the AC component of the signal is displayed at a higher sensitivity.
- If the channel adopts a GND coupling mode, cut off the input signal. Inside the channel, the channel input is connected with a zero volt reference electric level.

Fine Resolution

In the fine resolution setting, the vertical scale readout displays the actual VOLTS/DIV setting. The vertical scale changes only after you adjust the VOLTS/DIV control and set to coarse.

Remove Waveform Display

To remove a waveform from the screen, first push the menu button to display the vertical menu, then push again to remove the waveform. A channel waveform which is unnecessary to be displayed can be used as a trigger source or for math operations.

4. **MATH MENU:** Display the waveform math operations. See the table below for details.

The MATH menu contains source options for all math operations.

Operations	Source Options	Comments
+	CH1+CH2	Add Channel 1 to Channel 2.
-	CH1-CH2	Subtract the Channel 2 waveform from the Channel 1 waveform.
	CH2-CH1	Subtract the Channel 1 waveform from the Channel 2 waveform.
X	CH1xCH2	Channel 1 multiply channel 2
/	CH1/CH2	Channel 1 divide channel 2
	CH2/CH1	Channel 2 divide channel 1
FFT	CH1 or CH2	Three types of window available for selection: Hanning, Flattop, Rectangular.
		Zoom: Use the FFT Zoom button to adjust the window size. Scale: x1, x2, x5, x10.

Note: All selected menus are highlighted in orange.

2.7.2 Math FFT

This chapter elaborates how to use the Math FFT (Fast Fourier Transform). You can use the Math

FFT mode to convert a time-domain (YT) signal into its frequency components (spectrum), and to observe the following types of signals:

- Analyze harmonics in power cords;
- Measure harmonic content and distortion in systems;
- Characterize noise in DC power supplies;
- Test impulse response of filters and systems;
- Analyze vibration.

To use the Math FFT mode, perform the following tasks:

- Set the source (time-domain) waveform;
- Display the FFT spectrum;
- Choose a type of FFT window;
- Adjust the sample rate to display the fundamental frequency and harmonics without aliasing;
- Use zoom controls to magnify the spectrum;
- Use cursors to measure the spectrum.

2.7.2.1 Setting Time-domain Waveform

It is necessary to set the time-domain (YT) waveform before using the FFT mode. Follow the steps below.

1. Push the AUTOSSET button to display a YT waveform.
2. Turn the VERTICAL POSITION knob to vertically move the YT waveform to the center (zero division) so as to ensure the FFT will display a true DC value.
3. Turn the HORIZONTAL POSITION knob to position the part of the YT waveform to be analyzed in the center eight divisions of the screen. The oscilloscope uses the 2048 center points of the time-domain waveform to calculate the FFT spectrum.
4. Turn the VOLTS/DIV knob to ensure the entire waveform remains on the screen. If the entire waveform is invisible, the oscilloscope may display wrong FFT results by adding high-frequency components.
5. Turn the SEC/DIV knob to provide the resolution you need in the FFT spectrum.
6. If possible, set the oscilloscope to display multiple signal cycles.

If you turn the SEC/DIV knob to select a faster setting (fewer cycles), the FFT spectrum will display a larger frequency range and reduce the possibility of FFT aliasing.

To set the FFT display, follow the steps below.

1. Push the MATH MENU button;
2. Set the Operation option to FFT;
3. Select the Math FFT Source channel.

In many situations, the oscilloscope can also generate a useful FFT spectrum despite the YT

waveform not being triggered. This is especially true if the signal is periodic or random (such as noise).

Note: *You should trigger and position transient or burst waveforms as close as possible to the screen center.*

Nyquist Frequency

The highest frequency that any real-time digital oscilloscope can measure without errors is half of the sample rate, which is called the Nyquist frequency. Frequency information beyond the Nyquist frequency is undersampled which brings about the FFT aliasing. The math function can convert the center 2048 points of the time-domain waveform to an FFT spectrum. The resulting FFT spectrum contains 1024 points from DC (0Hz) to the Nyquist frequency. Usually, the screen compresses the FFT spectrum horizontally to 250 points, but you can use the FFT Zoom function to expand the FFT spectrum so that you can clearly view the frequency components at each of the 1024 data points in the FFT spectrum.

Note: *The oscilloscope's vertical response is a little bit larger than its bandwidth (70MHz, 100MHz or 200MHz, depending on the model; or 20MHz when the Bandwidth Limit option is set to Limited). Therefore, the FFT spectrum can display valid frequency information above the oscilloscope bandwidth. However, the amplitude information near or above the bandwidth will not be accurate.*

2.7.2.2 Displaying FFT Spectrum

Push the MATH MENU button to display the Math menu. Use the options to select the Source channel, the Window algorithm and the FFT Zoom factor. Only one FFT spectrum can be displayed at a time.

Math FFT Options	Settings	Comments
Source	CH1, CH2	Choose a channel to be the FFT source.
Window	Hanning, Flattop, Rectangular	Select a type of the FFT window. For more information, refer to Section 2.7.2.3 .
FFT Zoom	X1, X2, X5, X10	Change the horizontal magnification of the FFT display. For detailed information, refer to Section 2.7.2.6 .

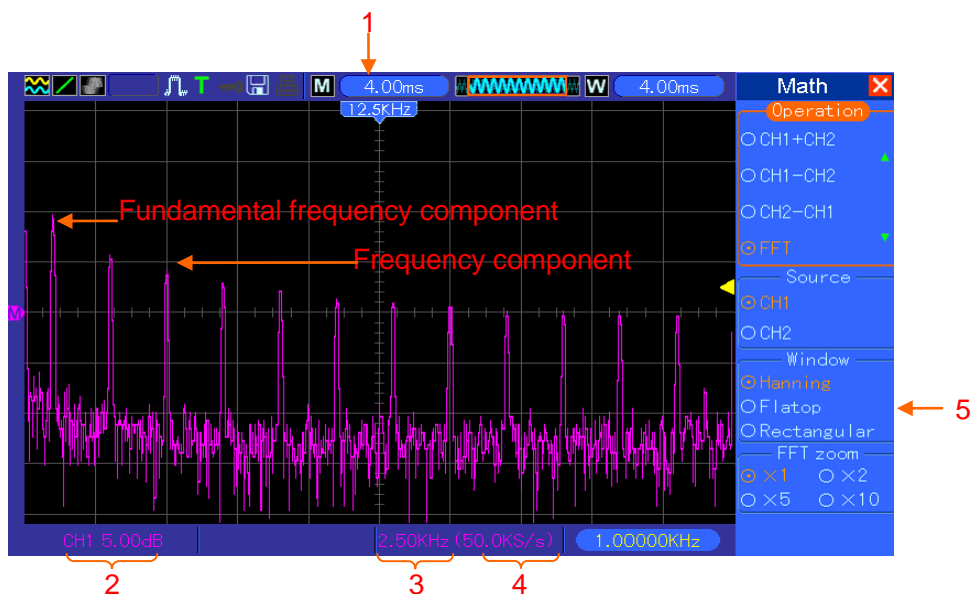

1. Frequency at the center graticule line
2. Vertical scale in dB per division ($0\text{dB}=1V_{\text{RMS}}$)
3. Horizontal scale in frequency per division
4. Sample rate in number of samples per second
5. FFT window type

2.7.2.3 Selecting FFT Window

Using windows can eliminate the spectral leakage in the FFT spectrum. The FFT algorithm assumes that the YT waveform repeats all the time. When the number of cycles is integral (1, 2, 3 ...), the YT waveform starts and ends at the same amplitude and there are no discontinuities in the signal shape.

If the number of cycles is nonintegral, the YT waveform starts and ends at different amplitudes and transitions between the start and end points will cause discontinuities in the signal that introduces high-frequency transients.

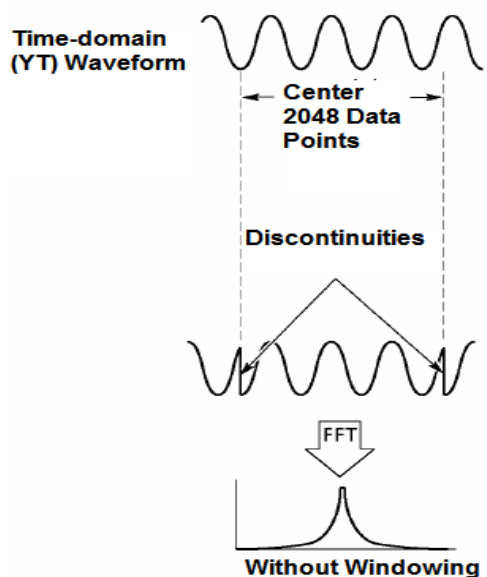

Applying a window to the YT waveform changes the waveform so that the start and stop values are close to each other, which reduces the discontinuities.

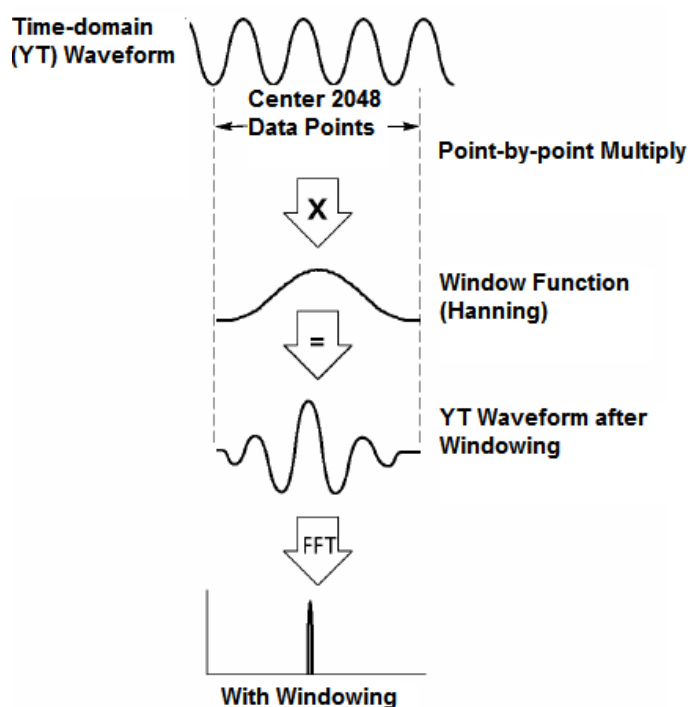

The Math FFT function has three FFT Window options. There is a trade-off between frequency resolution and amplitude accuracy for each type of window. You shall determine which one to choose according to the object you want to measure and the source signal characteristics.

Window	Measurement	Characteristics
Hanning	Periodic Waveform	Better frequency, poorer amplitude accuracy than Flattop
Flattop	Periodic Waveform	Better amplitude, poorer frequency accuracy than Hanning
Rectangular	Pulse or Transient Waveform	Special-purpose window applicable to discontinuous waveforms. This is actually the same as no windows.

2.7.2.4 FFT Aliasing

Problems occur when the time-domain waveform acquired by the oscilloscope contains frequency components higher than the Nyquist frequency. The frequency components above the Nyquist frequency will be undersampled and displayed as lower frequency components that 'fold back' from the Nyquist frequency. These erroneous components are called aliases.

2.7.2.5 Eliminating Aliases

To eliminate aliases, use the following methods.

- Turn the SEC/DIV knob to set a faster sample rate. Because the Nyquist frequency increases as you increase the sample rate, the aliased frequency components will be displayed correct. If too many frequency components appear on the screen, you may use the FFT Zoom option to magnify the FFT spectrum.
- If there is no need to observe the frequency components above 20MHz, set the Bandwidth Limit option to Limited.
- Filter the signal input from outside and limit the bandwidth of the source waveform to lower than the Nyquist frequency.
- Identify and ignore the aliased frequencies.
- Use zoom controls and cursors to magnify and measure the FFT spectrum.

2.7.2.6 Magnifying and Positioning FFT Spectrum

You may scale the FFT spectrum and use cursors to measure it through the FFT Zoom option which enables the horizontal magnification. To vertically magnify the spectrum, use the vertical controls.

Horizontal Zoom and Position

You can use the FFT Zoom option to magnify the FFT spectrum horizontally without changing the sample rate. The available zoom factors are X1(default), X2, X5 and X10. When the zoom factor is set to X1 and the waveform is located at the center graticule, the left graticule line is at 0Hz and the right is at the Nyquist frequency.

You magnify the FFT spectrum to the center graticule line when you change the zoom factor. That is, the axis for horizontal magnification is the center graticule line. Turn the Horizontal Position knob clockwise to move the FFT spectrum to the right. Push the SET TO ZERO button to position the center spectrum at the center of the graticule.

Vertical Zoom and Position

When the FFT spectrum is being displayed, the channel vertical knobs become the zoom and position controls corresponding to their respective channels. The VOLTS/DIV knob provides the following zoom factors: X1(default), X2, X5 and X10. The FFT spectrum is magnified vertically to the marker M (math waveform reference point on the left edge of the screen). Turn the VERTICAL POSITION knob clockwise to move up the spectrum.

2.7.2.7 Using Cursors to Measure FFT Spectrum

You may use cursors to take two measurements on the FFT spectrum: amplitude (in dB) and frequency (in Hz). Amplitude is referenced to 0db that equals 1VRMS here. You may use cursors to measure at any zoom factor.

Push the CURSOR button, choose the Source option and then select Math. Press the Type option button to select between Amplitude and Frequency. Click the SELECT CURSOR option to choose a cursor. Then use the V0 knobs to move Cursor S and Cursor E. Use the horizontal cursor to measure the amplitude and the vertical cursor to measure the frequency. Now the display at the DELTA menu is just the measured value, and the values at Cursor S and Cursor E.

Delta is the absolute value of Cursor S minus Cursor E.

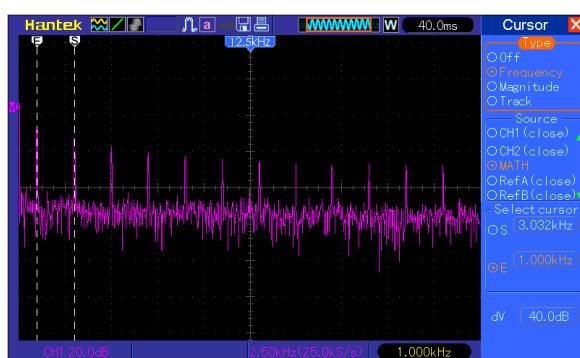

Frequency Cursors

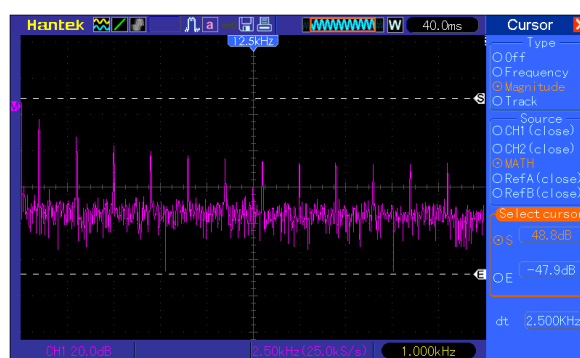

Amplitude Cursors

2.8 Trigger System

The trigger determines when the oscilloscope begins to acquire data and display a waveform. Once a trigger is properly set up, the oscilloscope can convert unstable displays or blank screens to meaningful waveforms. Here introduce some basic concepts about trigger.

Trigger Source: The trigger can be generated with multiple sources. The most common one is the input channel (alternative between CH1 and CH2). Whether the input signal is displayed or not, it can trigger normal operations. Also the trigger source can be any signal connected to an external trigger channel or the AC power line (only for Edge triggers). The source with the AC power line shows the frequency relationship between the signal and the AC commercial power.

Trigger Type: The oscilloscope has six types of triggers: Edge, Video, Pulse Width, Slope, Overtime and Swap.

- **Edge Trigger** uses the analog or digital test circuits for triggering. It happens when the input trigger source crosses a specified level in a specified direction.
- **Video Trigger** performs a field or line trigger through standard video signals.
- **Pulse Width Trigger** can trigger normal or abnormal pulses that meet trigger conditions.

- **Slope Trigger** uses the rise and fall times on the edge of signal for triggering.
- **Overtime Trigger** happens after the edge of signal reaches the set time.
- **Swap Trigger**, as a feature of analog oscilloscopes, gives stable displays of signals at two different frequencies. Mainly it uses a specific frequency to switch between two analog channels CH1 and CH2 so that the channels will generate swap trigger signals through the trigger circuitry.

Trigger Mode: You can select the Auto or Normal mode to define how the oscilloscope acquires data when it does not detect a trigger condition. **Auto Mode** performs the acquisition freely in absence of valid trigger. It allows the generation of untriggered waveforms with the time base set to 80ms/div or slower. **Normal Mode** updates the displayed waveforms only when the oscilloscope detects a valid trigger condition. Before this update, the oscilloscope still displays the old waveforms. This mode shall be used when you want to only view the effectively triggered waveforms. In this mode, the oscilloscope displays waveforms only after the first trigger. To perform a **single sequence acquisition**, push the SINGLE SEQ button.

Trigger Coupling: Trigger Coupling determines which part of the signal will be delivered to the trigger circuit. This can help to obtain a stable display of the waveform. To use trigger coupling, push the TRIG MENU button, select an Edge or Pulse trigger, and then select a Coupling option.

Trigger Position: The horizontal position control establishes the time between the trigger position and the screen center.

Slope and Level: The Slope and Level controls help to define the trigger. The Slope option determines whether the trigger point is on the rising or falling edge of a signal. To perform the trigger slope control, press the TRIG MENU button, select an Edge trigger, and use the Slope button to select rising or falling. The TRIGGER LEVEL knob controls the trigger point is on which position of the edge.

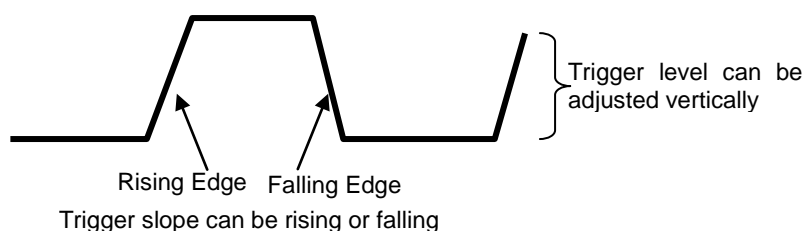

2.8.1 Trigger Controls

The trigger can be defined through the Trigger Menu and front-panel controls. There are six types of trigger: Edge, Video, Pulse Width, Swap, Slope and Overtime. Refer to the following tables to find a different set of options for each type of trigger.



1. Level

It sets the amplitude level the signal must cross to cause an acquisition when using the Edge or Pulse Width trigger.

2. Set to 50%

The trigger level is set to the vertical midpoint between the peaks of the trigger signal.

3. Force Trigger

Be used to complete an acquisition regardless of an adequate trigger signal. This button becomes useless if the acquisition is already stopped.

4. TRIG MENU

Push this button to display trigger menus. The edge trigger is in common use. See the table below for details.

Options	Settings	Comments
Trigger Type		
Edge Video Pulse Slope Swap Overtime		By default the oscilloscope uses the edge trigger which triggers the oscilloscope on the rising or falling edge of the input signal when it crosses the trigger level (threshold).
Source	CH1 CH2 EXT EXT/5 AC Line	Select the input source as the trigger signal. CH1, CH2: No matter the waveform is displayed or not, a certain channel will be triggered. EXT: Does not display the trigger signal and allows a trigger level range of +1.6V to -1.6V. EXT/5: Same as EXT option, but attenuates the signal by a factor of 5 and allows a trigger level range of +8V to -8V. AC Line: Uses a signal derived from the power cord as the trigger source.
Mode	Auto Normal	Select a trigger mode. By default, the oscilloscope uses the Auto mode. In this mode, the oscilloscope is forced to trigger when it does not detect a

		<p>trigger within a certain amount of time based on the SEC/DIV setting. The oscilloscope goes into the scan mode at 80ms/div or slower time base settings.</p> <p>In the Normal mode, the oscilloscope updates the display only when it detects a valid trigger condition. New waveforms are not displayed until they replace old ones. Use this mode to just view valid triggered waveforms. Only after the first trigger does the display appear.</p>
Coupling	AC DC HF Reject LF Reject	<p>Select the components of the trigger signal applied to the trigger circuitry.</p> <p>AC: Blocks DC components and attenuates signals below 10Hz.</p> <p>DC: Passes all components of the signal.</p> <p>HF Reject: Attenuates the high-frequency components above 80kHz.</p> <p>LF Reject: Blocks DC components and attenuates the low-frequency components below 8kHz.</p>

NOTE: Trigger coupling only affects the signal passed through the trigger system. It does not affect the bandwidth or coupling of the signal displayed on the screen.

Video Trigger

Options	Settings	Comments
Video		With Video highlighted, an NTSC, PAL or SECAM standard video signal will be triggered. The trigger coupling is preset to AC.
Source	CH1 CH2 EXT EXT/5	Select the input source as the trigger signal. Ext and Ext/5 use the signal applied to the EXT TRIG connector as the source.
Polarity	Normal Inverted	Normal: Triggers on the negative edge of the sync pulse. Inverted: Triggers on the positive edge of the sync pulse.
Sync	All Lines Line Number Odd Field Even Field All Fields	Choose a proper video sync. When selecting Line Number for the Sync option, you may use the User Select knob to specify a line number.
Standard	NTSC PAL/SECAM	Choose a video standard for sync and line number count.

Note: When you choose Normal Polarity, the trigger always occurs on negative-going sync pulses. If the video signal contains positive-going sync pulses, use the Inverted Polarity option.

Pulse Width Trigger

You can use it to trigger on aberrant pulses.

Options	Settings	Comments
Pulse		With Pulse highlighted, the trigger occurs on pulses that meet the trigger condition (defined by the Source, When and Set Pulse Width options).
Source	CH1 CH2 EXT EXT5	Select the input source as the trigger signal.
When	= ≠ < >	Select the trigger condition.
Set Pulse Width	20ns to 10.0sec	With Set Pulse Width highlighted by pressing F4, turn the multi-functional knob to set the pulse width.
Polarity	Positive Negative	Select to trigger on positive or negative pulses.
Mode	Auto Normal	Select the type of trigger. The Normal mode is best for most pulse width trigger applications.
Coupling	AC DC HF Reject LF Reject	Select the components of the trigger signal applied to the trigger circuit.
More		Switch between submenu pages.

Trigger When: The pulse width of the source must be $\geq 5\text{ns}$ so that the oscilloscope can detect the pulse.

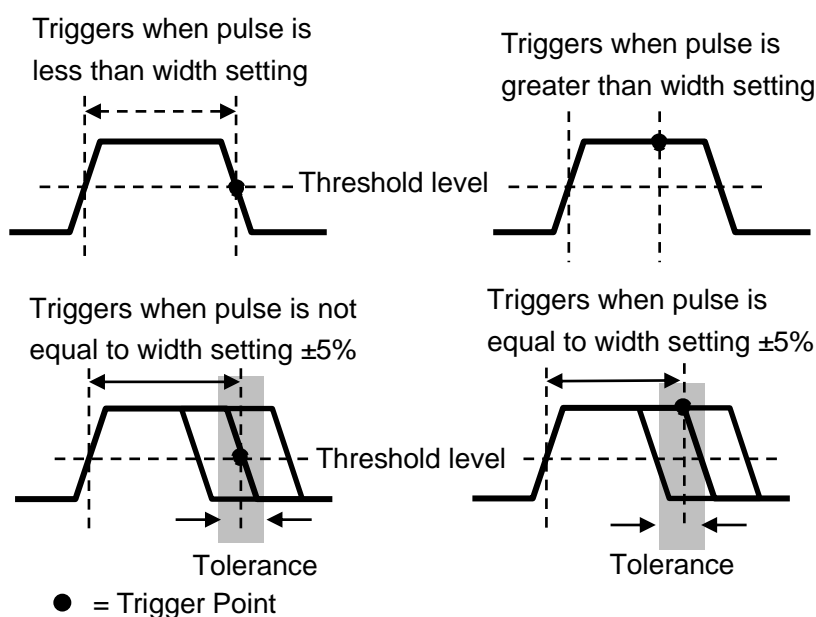

=, ≠: Within a $\pm 5\%$ tolerance, triggers the oscilloscope when the signal pulse width is equal to or not equal to the specified pulse width.

<, >: Triggers the oscilloscope when the source signal pulse width is less than or greater than the specified pulse width.

Slope Trigger: Judges trigger according to the time for rising or falling, more flexible and accurate than the Edge trigger.

Options	Settings	Comments
Slope		
Source	CH1 CH2 EXT EXT5	Select the input source as the trigger signal.
Slope	Rising Falling	Select the slope type of signal.
Mode	Auto Normal	Select the type of trigger. The Normal mode is best for most pulse width trigger applications.
Coupling	AC DC Noise Reject HF Reject LF Reject	Selects the components of the trigger signal applied to the trigger circuitry.
Next Page		
Vertical	V1 V2	Adjust the vertical window by setting two trigger levels. Select this option and press F3 to choose V1 or V2.
When	= ≠ < >	Select the trigger condition.
Time	20ns to 10.0sec	With this option highlighted by pressing F4, turn the multi-functional knob to set the time span.

Swap Trigger: As a feature of analog oscilloscopes, it gives stable displays of signals at two different frequencies. Mainly it uses a specific frequency to switch between two analog channels CH1 and CH2 so that the channels will generate swap trigger signals through the trigger circuitry.

Options	Settings	Comments
Swap Trigger		
Mode	Auto Normal	Select the type of trigger.
Channel	CH1 CH2	Push an option such as CH1, select the channel trigger type and set the menu interface.

Below list options in submenus. Swap Trigger allows CH1 and CH2 to select different trigger modes and to display waveforms on a same screen. That is, both channels can choose the following four trigger modes.

Type	Edge	
Slope	Rising Falling	

Coupling	AC DC HF Reject LF Reject	Push F3 or F4 to select the components of the trigger signal applied to the trigger circuitry.
Type	Video	
Polarity	Normal Inverted	
Standard	NTSC PAL/SECAM	
Sync	All Lines Line Number Odd Field Even Field All Fields	Select by F4, F5.
Type	Pulse	
Polarity	Positive Negative	
When	= ≠ < >	Select by F3.
Set Pulse Width	Pulse Width	Push F4 to select. Adjust the multi-functional knob V0 to set the pulse width.
Coupling	AC DC Noise Reject HF Reject LF Reject	Select by F5.
Type	Slope	
Slope	Rising Falling	Select the slope type of signal.
Mode	Auto Normal	Select the type of trigger. The Normal mode is best for most pulse width trigger applications.
Coupling	AC DC Noise Reject HF Reject LF Reject	Selects the components of the trigger signal applied to the trigger circuitry.
Vertical	V1 V2	Adjust the vertical window by setting two trigger levels. Select this option and press F3 to choose V1 or V2.
When	= ≠ < >	Select the trigger condition.
Time	20ns to 10.0sec	Press F4 to select this option. Turn the multi-functional

		knob to set the time span.
--	--	----------------------------

Overtime Trigger: In Pulse Width trigger, you may sometimes be puzzled with the long time for trigger, as you do not need a complete pulse width to trigger the oscilloscope, but want the trigger occurs just upon the overtime point. This is called Overtime Trigger.

Options	Settings	Comments
Type	OT	
Source	CH1 CH2	Select the trigger source.
Polarity	Positive Negative	Select to trigger on positive or negative pulses.
Mode	Auto Normal	
Overtime	τ	Press F5 to select Overtime option and adjust V0 to set the time.
Coupling	AC DC HF Reject LF Reject	Selects the components of the trigger signal applied to the trigger circuitry.

Holdoff: To use Trigger Holdoff, push the HORIZONTAL Menu button and set the Holdoff Time option by pressing F4. The Trigger Holdoff function can be used to generate a stable display of complex waveforms (such as pulse trains). Holdoff is the time between when the oscilloscope detects one trigger and when it is ready to detect another. During the holdoff time, the oscilloscope will not trigger. For a pulse train, the holdoff time can be adjusted to let the oscilloscope trigger only on the first pulse in the train.

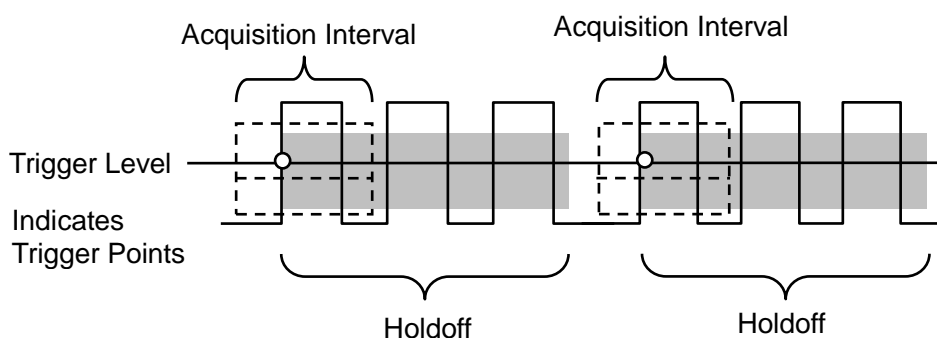

2.9 Save/Recall

Press the SAVE/RECALL button to save or recall oscilloscope setups or waveforms.

The first page shows the following menu.

Options	Settings	Comments
REF		REF is used as a reference waveform. The format is custom.
Source	CH1 CH2	Select a waveform source to store.

	MATH	
Location	RefA RefB	Select the reference location to store or recall a waveform.
Operation	Save	Save the source waveform to the selected reference location.
	Recall	Recall saved source waveform to the selected reference location.
	Close	Close Ref channel.

Page 2/2

Media	Flash	Save the source waveform to flash.
	USB	Save the source waveform to USB device.
	SD	Save the source waveform to SD card.
Back	Return to main menu.	

Options	Settings	Comments
Setup		The oscilloscope settings.
Storage	Local Memory USB	Store the current setups to the USB disk or the memory of the oscilloscope.
Location	0 to 9	Specify the memory location in which to store the current waveform settings or from which to recall the waveform settings. Use the F2 or F3 button to select.
Operation	Save	Complete the saving operation.
	Recall	Recall the oscilloscope settings stored in the location selected in the Setup field. Push the Default Setup button to initialize the oscilloscope to a known setup.
Back	Return to main menu.	

Options	Settings	Comments
CSV		The table for recording the voltage of each point.
Source	CH1 CH2	Select a waveform source to store.
Operation	Save	Save waveform data as .CSV file to USB disk.
	Recall	Recall the saved .CSV file stored in USB disk.
	Delete	Delete .CSV file stored in USB disk.
File List	Close	Close file list.
	Open	Open file list.
Back	Return to main menu.	

Options	Settings	Comments
Default		Push the Default softkey to initialize the oscilloscope to a known setup. Please refer to Default Setup .

See below for waveform menus.

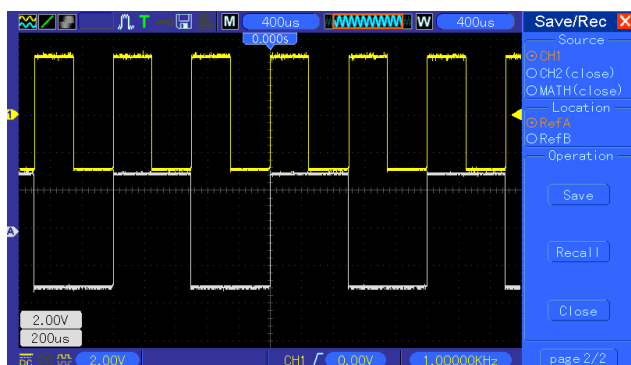

The white waveforms on the menu is the recalled RefA waveform

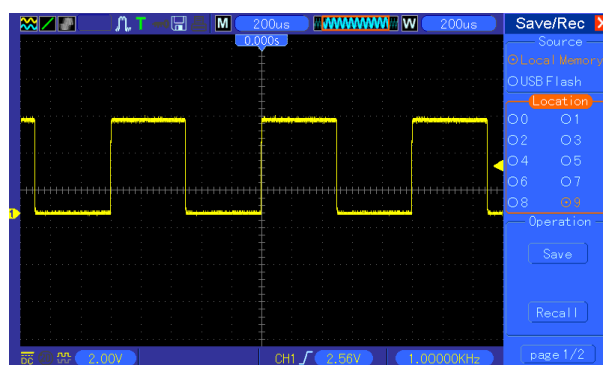

At most 9 groups of setups can be stored

Note: The oscilloscope will save the current settings if you wait 5 seconds after the last modification, and it will recall these settings the next time you power on the oscilloscope.

2.10 Display System

[DISPLAY] is a function key of the display system.

Page 1 of the display system function menu:

Option	Setup	Description
Type	Vector Dots	The sampling points are displayed in a link line manner. No interpolation link line is displayed between the sampling points. Display sample points directly
Persist	Auto, 0.2s 0.4s, 0.8s 1.0s, 2.0s 4.0s, 8.0s ∞	Set the maintained display time length of each displayed sampling point.
Format	YT XY	YT format shows the vertical voltage in relation to time (horizontal scale); XY format displays a dot between CH1 and CH2 each time
Contrast		0-15 16 ranks adjustable, with a progress bar to display; Press F5 to select this option. Turn the multi-functional knob to adjust.
Page 1/2		Skip to the next page.

Page 2 of the display system function menu:

Option	Setup	Description
Grid	Dotted line Real line Off	Only horizontal coordinate and vertical coordinate in the middle of the level will display on the screen when grid is off.
Grid Intensity		0-15 16 ranks adjustable, with a progress bar to display

Refresh Rate		Auto, 30 frame, 40 frame, 50frame
Wave Intensity		0-15 16 ranks adjustable, with a progress bar to display

2.10.1 XY Format

The XY format is used to analyze phase differences, such as those represented by Lissajous patterns. The format plots the voltage on CH1 against the voltage on CH2, where CH1 is the horizontal axis and CH2 is the vertical axis. The oscilloscope uses the untriggered Normal acquisition mode and displays data as dots. The sampling rate is fixed at 1 MS/s.

The oscilloscope can acquire waveforms in YT format at any sampling rate. You may view the same waveform in XY format. To perform this operation, stop the acquisition and change the display format to XY.

The table below shows how to operate some controls in XY format.

Controls	Usable or not in XY format
CH1 VOLTS/DIV and VERTICAL POSITION controls	Set the horizontal scale and position
CH2 VOLTS/DIV and VERTICAL POSITION controls	Continuously set the vertical scale and position
Reference or Math	Unusable
Cursors	Unusable
Autoset (display format reset to YT)	Unusable
Time base controls	Unusable
Trigger controls	Unusable

2.11 Measure System

The oscilloscope can use scale and cursor for measurement or automatic measurement, so that users can fully understand the measured signals.

2.11.1 Scale measurement

By using the method, estimation can be made quickly and intuitively. For instance, waveform amplitude can be observed, and a probable measurement result is judged according to the vertical scale. The method realizes simple measurement by multiplying the vertical scale number of the signal with the vertical gear Volt/div.

2.11.2 Cursor measurement

[CURSORS] is a function key for cursor measurement.

The cursor measurement includes two modes: Manual mode and Tracking mode.

1. Manual mode:

Horizontal cursors or vertical cursors appear in pair to measure time or voltage, and the distance between the cursors can be manually regulated. The signal source should be set as a waveform to be measured before the cursors are used.

2. Tracking mode:

A horizontal cursor is intersected with a vertical cursor to form a cross cursor. The cross cursor is automatically located on the waveform, and the horizontal position of the cross cursor on the waveform is regulated by selecting “Cur A” or “Cur B” and rotating the [UNIVERSAL] knob. The coordinates of the cursor point will be displayed on the screen of the oscilloscope.

Manual cursor measurement mode

Manual cursor measurement function menu:

Option	Setup	Description
Cursor mode	Manual	Set the manual cursor measurement
Types	Voltage	Manually use the cursor to measure voltage parameters.
	Time	Manually use the cursor to measure time parameters.
Signal sources	CH1 CH2 MATH REF A REF B	Select the input channel of the measured signal.
Cursor select	S	Select the option using the [UNIVERSAL] knob to regulate the position of “S”.
	E	Select the option using the [UNIVERSAL] knob to regulate the position of “E”.

The manual cursor measurement mode is used for measuring the coordinate values and increments of one pair of horizontal or vertical cursors. Ensure the signal source to be set rightly when using the cursors, as shown in figure 2-38.

■ **Voltage cursor:** The voltage cursor appears on the display screen as a horizontal line, and it can be used for measuring vertical parameters.

■ **Time cursor:** The time cursor appears on the display screen as a vertical line, and it can be used for measuring horizontal parameters.

■ **Cursor movement:** Select the cursors first and use the [UNIVERSAL] knob to move cursor A and cursor B, wherein the values of the cursors will appear on the right upper corner of the screen during movement.

The operation steps are as follows:

1. Press [CURSORS] to skip to the “CURSOR” menu.
2. Press “Type” to select “Voltage” or “Time”.

3. Press **“Signal source”** to select CH1, CH2, MATH, RefA or RefB.
4. Select **“S”** and revolve the **[UNIVERSAL]** knob to regulate the position of **“S”**.
5. Select **“E”** and revolve the **[UNIVERSAL]** knob to regulate the position of **“E”**.
6. The measurement value list on the menu button **“F5”**

Cursor tracking measurement mode

Cursor tracking function menu:

Option	Setup	Description
Cursor mode	Tracking	Set the tracking cursor measurement.
Source	CH1 CH2 MATH RefA RefB	Select a waveform source to take the cursor measurement.
Select Cursor	“S” “E”	Select the option using the [UNIVERSAL] knob to regulate the position of “S”. Select the option using the [UNIVERSAL] knob to regulate the position of “E”.

At cursor tracking measurement mode, the cross cursors are displayed on the measured waveform, the cursors are automatically located on the waveform by moving the horizontal position between the cursors, and simultaneously the horizontal and vertical coordinates of the current located point, and the horizontal and vertical increments between the two cursors are displayed. The horizontal coordinate is displayed as a time value, and the vertical coordinate is displayed as a voltage value, as shown in figure 2-39.

The operation steps are as follows:

1. Press **[CURSORS]** to skip to the **“CURSOR”** menu.
2. Select **“Cursor type”** as **“Tracking”**.
3. Press **“S”**, and select the input channel CH1 or CH2 of the tracked signal.
4. Press **“E”**, and select the input channel CH1 or CH2 of the tracked signal.
5. Press **“S”**, and rotate the **[UNIVERSAL]** knob to horizontally move **“S”**.
6. Press **“E”**, and rotate the **[UNIVERSAL]** knob to horizontally move **“E”**.
7. The measurement value list on the menu button **“F5”**

S→T: Position (namely the time based on the horizontal central position) of **“S”** in the horizontal direction.

S→V: Position (namely the voltage based on the grounded point of the channel) of **“S”** in the vertical direction.

E→T: Position (namely the time based on the horizontal central position) of **“E”** in the horizontal direction.

E→V: Position (namely the voltage based on the grounded point of the channel) of **“E”** in the vertical direction.

dt: Horizontal distance (namely the time value between the two cursors) of “S” and “E”.

1/dt: Frequency of “S” and “E”.

dV: Vertical distance (namely the voltage value between the two cursors) of “S” and “E”.

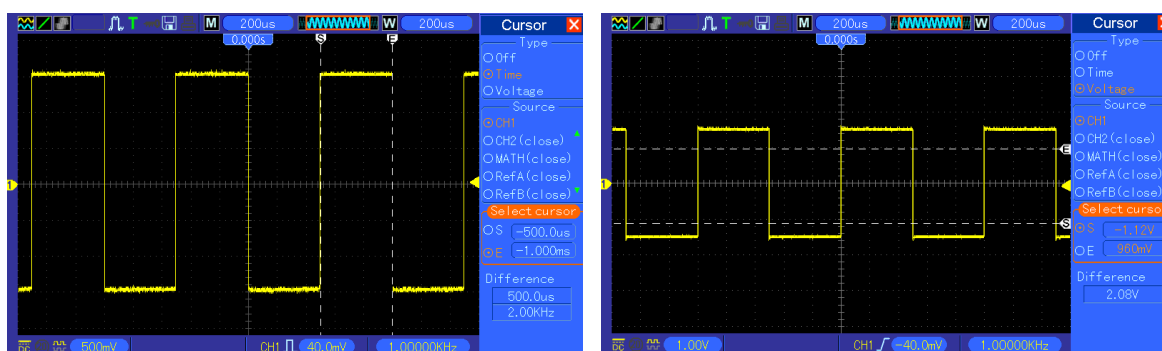

Time Cursor

Voltage Cursor

2.11.3 Measurement

Push the MEASURE button to perform auto measurements. There are 32 types of measurements and up to 8 can be displayed at a time.

Turn the V0 knob to select an unspecified option. Press V0 or F6 when the red arrow icon stops on it. Then the following menu appears.

Use the knob V0 or the functional keys to select the type of measurement. Measurement setting is described as shown in table:

Options	Settings	Comments
Source	CH1 CH2	Select the measure source.
Measurement Type		
1	Frequency	Calculate the waveform frequency by measuring the first cycle.
2	Period	Calculate the time of the first cycle.
3	Mean	Calculate the arithmetic mean voltage over the entire waveform.
4	Pk-Pk	Calculate the absolute difference between the greatest and the smallest peaks of the entire waveform.
5	CRMS	Calculate the Root Mean Square voltage over the entire waveform.
6	PRMS	Calculate the actual RMS measurement of the first complete cycle in the waveform.
7	Min	The most negative peak voltage measured over the entire waveform.
8	Max	The most positive peak voltage measured over the entire waveform.
9	Rising	Measure the time between 10% and 90% of the first rising edge of the waveform.
10	Falling	Measure the time between 90% and 10% of the first falling edge of the waveform.

11	+ Width	Measure the time between the first rising edge and the next falling edge at the waveform 50% level.
12	- Width	Measure the time between the first falling edge and the next rising edge at the waveform 50% level.
13	+ Duty	Measure the first cycle waveform. Positive Duty Cycle is the ratio between positive pulse width and period.
14	- Duty	Measure the first cycle waveform. Negative Duty Cycle is the ratio between positive pulse width and period.
15	Base	Measure the highest voltage over the entire waveform.
16	Top	Measure the lowest voltage over the entire waveform.
17	Middle	Measure the voltage of the 50% level from base to top.
18	Amplitude	Voltage between Vtop and Vbase of a waveform.
19	Overshoot	Defined as $(\text{Base} - \text{Min})/\text{Amp} \times 100 \%$, Measured over the entire waveform.
20	Preshoot	Defined as $(\text{Max} - \text{Top})/\text{Amp} \times 100 \%$, Measured over the entire waveform.
21	PMean	Calculate the arithmetic mean voltage over the first cycle in the waveform.
22	FOVShoot	Defined as $(\text{Vmin} - \text{Vlow})/\text{Vamp}$ after the waveform falling.
23	RPRESoot	Defined as $(\text{Vmin} - \text{Vlow})/\text{Vamp}$ before the waveform falling.
24	BWidth	The duration of a burst measured over the entire waveform.
25	Delay 1-2 ↑	The time between the first rising edge of source 1 and the first rising edge of source 2.
26	Delay 1-2 ↓	The time between the first falling edge of source 1 and the first falling edge of source 2.
27	LFF	The time between the first falling edge of source 1 and the last falling edge of source 2.
28	LFR	The time between the first falling edge of source 1 and the last rising edge of source 2.
29	LRF	The time between the first rising edge of source 1 and the last falling edge of source 2.
30	LRR	The time between the first rising edge of source 1 and the last rising edge of source 2.
31	FFR	The time between the first falling edge of source 1 and the first rising edge of source 2.
32	FRF	The time between the first rising edge of source 1 and the first falling edge of source 2.
	Off	Do not take any measurement.

Use the knob V0 or the functional keys F3, F4 to select the type of measurement.



The readouts in big font size on the menu are just results of the corresponding measurements.

Taking Measurements: For a single waveform (or a waveform divided among multiple waveforms), up to 8 automatic measurements can be displayed at a time. The waveform channel must stay in an 'ON' (displayed) state to facilitate the measurement. The automatic measurement can not be performed on reference or math waveforms, or in XY or Scan mode.

2.12 Acquisition System

Push the ACQUIRE button to set the acquisition parameter.

Options	Settings	Comments
Type	Real Time Equ-Time	Acquire waveforms by real-time digital technique. Rebuild waveforms by equivalent sample technique.
Mode (Real Time)	Normal Peak Detect Average	Acquire and accurately display most waveforms. Detect glitches and eliminate the possibility of aliasing. Reduce random or uncorrelated noise in signal display. The number of averages is selectable.
Averages (Real Time)	4, 8, 16, 32 64, 128	Select the number of averages by pressing F3 or F4.
Memory Depth (Real Time)	4K, 20K, 40K	Select the memory depth for different board models.

Normal: For the oscilloscope model with the bandwidth of 100MHz, the maximum sample rate is 1GS/s. For time base with insufficient sample rate, you may use the Sine Interpolation Algorithm to interpolate points between sampled points to produce a complete waveform record (4K by default).

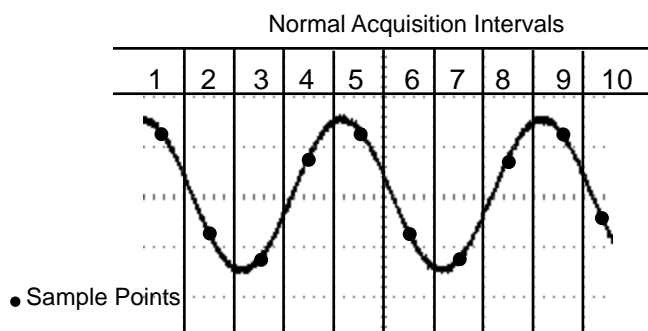

Normal Mode Acquires a Single Sample Point in Each Interval

Peak Detect: Use this mode to detect glitches within 10ns and to limit the possibility of aliasing. This mode is valid at the SEC/DIV setting of 4 μ s/div or slower. Once you set the SEC/DIV setting to 4 μ s/div or faster, the acquisition mode will change to Normal because the sample rate is fast enough that Peak Detect is unnecessary. The oscilloscope does not display a message to tell you that the mode has been changed to Normal.

Average: Use this mode to reduce random or uncorrelated noise in the signal to be displayed. Acquire data in Normal mode and then average a great number of waveforms. Choose the number of acquisitions (4, 16, 64 or 128) to average for the waveform.

Stopping the Acquisition: When you are running the acquisition, the waveform display is live. Stop the acquisition (press the RUN/STOP button) to freeze the display. In either mode, the waveform display can be scaled or positioned by vertical and horizontal controls.

Equivalent Acquisition: Just repeat the Normal acquisition. Use this mode to take a specific observation on repeatedly displayed periodic signals. You can get a resolution of 40ps, i.e. 25GSa/s sample rate, which is much higher than that obtained in real-time acquisition.

The acquisition principle is as follows.

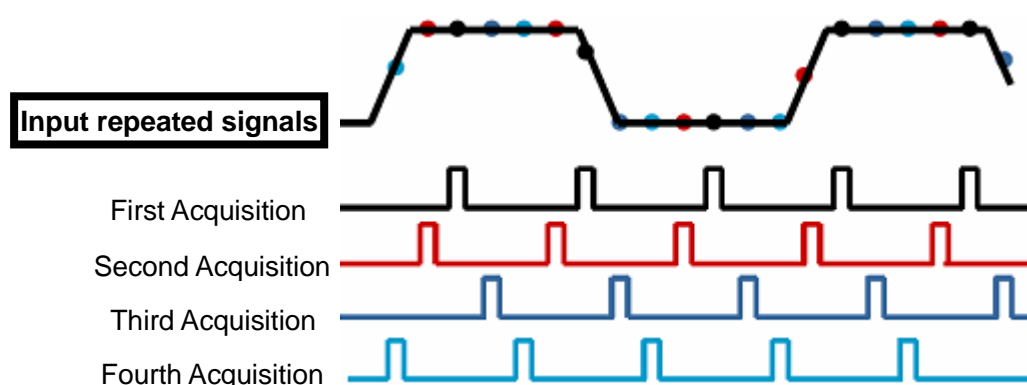

As shown above, acquire input signals (cycle repeatable) for more than once at a slow sample rate, arrange the sample points by the time they appear, then recover waveforms.

2.13 UTILITY System

Push the **UTILITY** button to display the Utility Menu as follows.

Options	Comments
System Info	Display the software and hardware versions, serial number and some other information about the oscilloscope.
Update Program	Insert a USB disk with upgrade program and the disk icon at the top left corner is highlighted. Press the Update Program button and the Software Upgrade dialog pops up. Push F6 to upgrade or push F2 to cancel.
Save Waveform	Feature Select (CH1 POSITION): position and screenshots. Position: Push this knob to return CH1 waveforms to the vertical center position on the screen. Screenshots: Insert a USB disk and the disk icon at the top left corner is highlighted. Push this knob and you can see the waveform pause for a while, being saved. You can find the saved waveform data under the pic_x_x folder in the USB disk. Here X represents how many times you press the button. Each press generates a corresponding folder. For example, press once and a folder pic_1_1 is generated; press twice and two folders pic_1_1, pic_1_2 are generated.
Self Calibration	Press this option and the Self Calibration dialog pops up. Press F6 to perform the self calibration. Press F4 to cancel.
Keypad Beep	Turn on or turn off key beep.
GUI Language	Set the language
GUI color	Set the GUI color, blue, black, green, pink, yellow.
Time	Set the time setting.
Sys Status	Display the system status.
Pass/Fail	Pass/Fail function
Recorder	Turn on record function.
Filter	Filter setting.
Print Cfg	Set print configuration
Option	Bode Assiant: Wave: Save waveform as .hws file to Flash, SD or USB device. DDS: Enable waveform generator function. DVM:



Tip: Press any menu button on the front panel to remove the status display and enter a corresponding menu.

2.13.1 Firmware Update

This series of oscilloscope can upgrade the software by the USB flash disc, which needs about 5 minutes.

The firmware is upgraded by the following steps:

1. Plug the USB flash disc in which a firmware program is saved in USB Host interface

on the front panel of the oscilloscope.

2. Press [UTILITY] to skip to the “UTILITY” menu.
3. Press “Firmware Update”.
4. Refer to Upgrade dialog and push F6 to upgrade.

Reboot the machine after finishing upgrading, and the software version is upgraded. The oscilloscope should be self-corrected once after upgrading.

2.13.2 Self Calibration

The self calibration routine helps optimize the oscilloscope signal path for maximum measurement accuracy. You can run the routine at any time but should always run it if the ambient temperature changes by 5°C or more. For a more accurate calibration, please power on the oscilloscope and wait for 20 minutes until it has adequately warmed up.

To compensate the signal path, disconnect any probes or cables from the front-panel input connectors. Then, push the UTILITY button, select the Do Self Cal option and follow the directions on the screen.

2.13.3 Keypad Beep Control

Press “Utility->F6” to page 2 of utility menu to select “Keypad Beep”. Press “F1” button to activate or deactivate it.

2.13.4 Language

This series oscilloscope is equipped with several languages. User can select a language.

To choose the display language, press "UTILITY" button, then press “F6” to utility menu. Press "F2" to switch language.

2.13.5 GUI Color Setting

This series oscilloscope is equipped with several GUI styles. User can select a style.

Press “Utility” button and “F6” button to page 2 of utility menu. Then press “F2” button to change GUI color style.

2.13.6 Time Setting

Press “Utility->F6” to page 2 of utility menu to select “Time”. Press “F4” button to set system time.

2.13.7 System Status

Press “Utility->F6” to page 2 of utility menu to select “Sys Status”. Users can know system status on screen.

2.13.8 Pass/fail

“Pass/fail” is used for judging whether the input signal is in a built rule range and outputting the past or failed waveform so as to detect the change condition of the signal.

Page 1 of the pass/fail function menu:

Option	Setup	Description
Enable Test	Run Stop	Run the pass/fail function. Stop the pass/fail function.
Source	CH1 CH2	Select the signal input channel.
Operation	Run Stop	Run pass/fail Stop pass/fail
Display information	Off On	Close waveform pass/fail time display information. Open waveform pass/fail time display information.
Page 1/2		Skip to page 2 to the pass/fail menu.

Page 2 of the pass/fail function menu:

Option	Setup	Description
Output	Pass Fail Pass Ring Fail Ring	Output a negative pulse train when the test is passed. Output a negative pulse train when the test is failed. Output a negative pulse train when the test is passed and rings. Output a negative pulse train when the test is failed and rings.
Stop on Output	On Off	Enter STOP state if output exits. Continue to run if output exits.
Rule setup		Skip to a rule setup menu.
Page 2/2		Back to t page 1 to the pass/fail menu.

Rule setup menu:

Option	Setup	Description
Vertical		Use the [UNIVERSAL] knob to set a horizontal tolerance range: 0.020div-4.00div.
Horizontal		Use the [UNIVERSAL] knob to set a vertical tolerance range: 0.025div-8.00div.
Operation	Create Save	Create a rule template according to the two setups above. Select a save position for the rule.
Back		Back to page 2 of the pass/fail menu.

Rule save menu:

Option	Setup	Description
Storage	Local Memory USB Flash	Select location of saved rule
Location	0-9	
Operation	Save Recall	Save the rule setups. Recall the waved rule setups.
Back		Back to page of the rule setup menu.

Pass/Fail output

The pass/fail function can be used for outputting a negative pulse train through a Pass/Fail BNC interface on a rear panel of the oscilloscope.

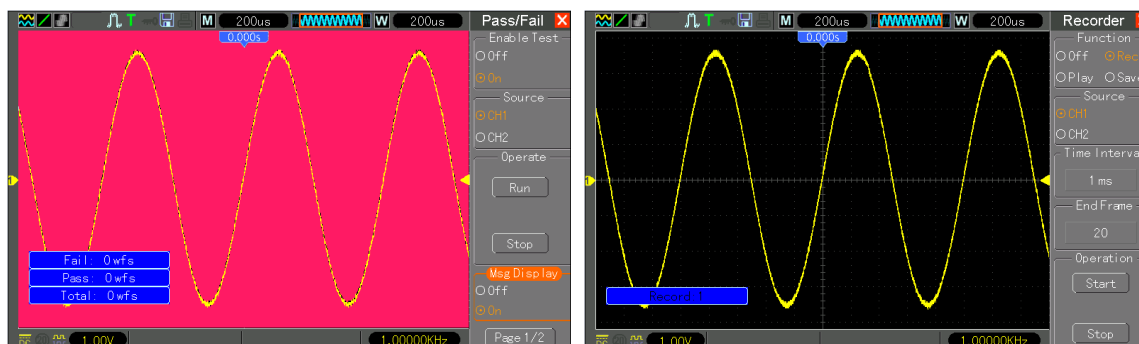

Pass/Fail Test result

Waveform recording

2.13.9 Recorder

The waveform recording function can be used for recording waveforms input by channel 1 and channel 2. The user can set the time interval of the frames within 1ms-999s. At most 1000 frames of waveforms can be recorded. The waveforms can be replayed after being recorded.

Waveform recording: Record the waveforms at a specified time interval until reaching the set end frame number.

Waveform recording function menu:

Option	Setup	Description
Function	Off Record Play Save	Set a recording function menu. Set a replay function menu.
Source	CH1 CH2	Set a recording signal source.
Time interval	1ms-999s	Set the time interval for waveform recording.
End Frame	1-1000	Set the Max. frame number of recording
Operation	Start Stop	Start to record the waveform. Stop recording the waveform.

As shown in figure 2-57, the operation steps of waveform recording are as follows:

1. Press **[UTILITY]** to skip to the **[UTILITY]** menu.
2. Press “**F6**” to skip to page 3 of the utility menu.
3. Press “**Recorder**” to skip to the “**RECORD**” menu.
4. Press the “**Function**” key to select “**Record**”.
5. Press the “**Source**” key to select the signal channel to be recorded.
6. Select the “Time interval” option, and use the **[V0]** knob to regulate the time interval of frame to frame in waveform recording.
7. Select the “**End frame**” option, and use the **[V0]** knob to regulate the maximal frame number in the waveform recording.

8. Press the **“Operation”** option “Start” to record the waveform.

Recording replay: Replay the current recorded waveforms.

Page 1 of the waveform replay function menu:

Option	Setup	Description
Function	Play	Set a replay function menu.
Mode	Repeat	Repeatedly replay the recorded waveform.
	Single	Replay the recorded waveform in single run.
Time interval		Set the time interval of the replayed frame to frame.
Start frame		Set start frame of playing
End frame		Set end frame of playing
Page 1/2		Skip to page 2 of play menu

Page 2 of the waveform replay function menu:

Option	Setup	Description
Current Frame		
Operation	Start	Start to replay waveform
	Stop	Stop to reply waveform
Page 2/2		Back to page 1 of the replay function menu.

2.13.10 Filter

Press “Utility->F6->F6” to page 3 of utility menu to select “Filter”. Press “F3” button to select filter type Low Pass, High Pass, Band Pass or Band Stop.

Low Pass

Source: Select a waveform source to filter.

Up: Set the upper limit of the cutoff frequency.

All the signals from 0Hz to the upper limit of cut-off frequency can be passed. And other signals will be limited.

High Pass

Source: Select a waveform source to filter.

Down: Set the lower limit of the cutoff frequency.

All the signals from 0Hz to the lower limit of cut-off frequency can be limited. And other signals will be passed.

Band Pass

Source: Select a waveform source to filter.

Up: Set the upper limit of the cutoff frequency.

Down: Set the lower limit of the cutoff frequency.

All the signals from down to up frequency can be passed. And other signals will be limited.

Band Stop

Up: Set the upper limit of the cutoff frequency.

Down: Set the lower limit of the cutoff frequency.

All the signals from down to up frequency can be limited. And other signals will be passed.

Note: The upper limit of the frequency is the sampling rate divided by 2.5.

2.13.11 Wave

Press "Utility->F6->F6" to page 3 of utility menu to select "Wave".

Options	Settings	Comments
Source	CH1 CH2	Select a waveform source to store.
Media	Flash	Save the source waveform to flash.
	USB	Save the source waveform to USB device.
	SD	Save the source waveform to SD card.
Location	0~99	Select stored location when save waveform to flash media.
Page 2/2		
Operation	Save	Save the source waveform to the selected reference location.
	Recall	Recall saved source waveform to the selected reference location.
	Delete	Delete saved waveform.
	SD to USB	Copy waveform files to USB device.

2.13.12 DDS

Press "Utility->F6->F6" to page 3 and select "Option->DDS" of utility menu to enable to waveform generator function.

2.13.13 DVM

Press "Utility->F6->F6" to page 3 and select "Option->DVM" of utility menu to calculate the Root Mean Square voltage over the entire waveform (CRMS).

2.14 Help System

This oscilloscope has a Help system with topics covering all of its features. You can use the Help system to display several kinds of information:

- ◆ General information about understanding and using the oscilloscope, such as Using the Menu System.
- ◆ Information about specific menus and controls, such as the Vertical Position Control.
- ◆ Advice to problems you may come across while using an oscilloscope, such as Reducing Noise.

The Help system provides three methods for you to find the information you want: context-sensitive, hyperlinks, and an index.

◆ Context-Sensitive

Push the HELP front-panel button and the oscilloscope displays information about the last menu displayed on the screen. The HELP SCROLL LED lights beside the HORIZONTAL POSITION knob indicate the alternative function of the knob. If a topic uses more than one page, turn the HELP SCROLL knob to move from page to page within the topic.

◆ Hyperlinks

Most of the help topics contain phrases marked with angle brackets, such as <Autoset>. They are links to other topics. Turn the HELP SCROLL knob to move the highlight from one link to another. Push the Show Topic option button to display the topic corresponding to the highlighted link. Press the Back option button to return to the previous topic.

◆ Index

Push the front-panel HELP button, and then press the Index option button. Push the Page Up or Page Down option button until you find the index page which contains the topic you want to view. Turn the HELP SCROLL knob to highlight a help topic. Press the Show Topic option button to display the topic.

NOTE: Press the Exit option button or any menu button to remove the Help text from the screen and return to displaying waveforms.

2.15 Fast Action Buttons



RUN/STOP: Continuously acquire waveforms or stop the acquisition.

SINGLE SEQ: Acquire a single waveform and then stop the acquisition.

AUTOSET: Automatically set the oscilloscope controls to generate a usable display of the input signals. Refer to the following table for relative content.

2.15.1 Autoset

Autoset is one of the advantages digital oscilloscopes have. When you push the AUTOSET button, the oscilloscope will identify the type of waveform (sine or square wave) and adjust controls according to input signals so that it can accurately display the waveform of the input signal.

Functions	Settings
Acquire Mode	Adjusted to Normal or Peak Detect
Cursor	Off
Display Format	Set to YT
Display Type	Set to Vectors for an FFT spectrum; otherwise, unchanged
Horizontal Position	Adjusted
SEC/DIV	Adjusted
Trigger Coupling	Adjusted to DC, Noise Reject or HF Reject
Trigger Holdoff	Minimum
Trigger Level	Set to 50%
Trigger Mode	Auto
Trigger Source	Adjusted; Autoset can not be used for the EXT TRIG signal
Trigger Slope	Adjusted
Trigger Type	Edge
Trigger Video Sync	Adjusted
Trigger Video Standard	Adjusted
Vertical Bandwidth	Full

Vertical Coupling	DC (if GND was chosen before); AC for the video signal; otherwise, unchanged
VOLTS/DIV	Adjusted

The Autoset function examines all channels for signals and displays corresponding waveforms. Autoset determines the trigger source according to the following conditions.

- If multiply channels get signals, the oscilloscope will use the channel with the lowest frequency signal as the trigger source.
- If no signals are found, the oscilloscope will use the lowest-numbered channel displayed in Autoset as the trigger source.
- If no signals are found and no channels are displayed, the oscilloscope will display and use Channel 1 as the trigger source.

Sine Wave:

When you use the Autoset function and the oscilloscope determines that the signal is similar to a sine wave, the oscilloscope displays the following options.

Sine Wave Options	Details
Multi-cycle Sine	Display multiple cycles that have appropriate vertical and horizontal scales.
Single-cycle Sine	Set the horizontal scale to display about one cycle of the waveform.
FFT	Convert the input time-domain signal to its frequency components and display the result as a graph of frequency versus amplitude (spectrum). Since it is a math calculation, see Section 2.7.2 Math FFT for more information.
Undo Setup	Let the oscilloscope recall the previous setup.

Square Wave or Pulse:

When you use the Autoset function and the oscilloscope determines that the signal is similar to a square wave or pulse, the oscilloscope displays the following options.

Square Wave Options	Details
Multi-cycle Square	Display multiple cycles that have appropriate vertical and horizontal scales.
Single-cycle Square	Set the horizontal scale to display about one cycle of the waveform. The oscilloscope displays Min, Mean and Positive Width automatic measurements.
Rising Edge	Display the rising edge.
Falling Edge	Display the falling edge.
Undo Setup	Let the oscilloscope recall the previous setup.

2.16 Waveform Generator

2.16.1 Set Wave Type and Parameters

QC1936 oscilloscope is equipped with waveform generator function, with one channel of arbitrary waveform output. User can edit the arbitrary waveform or choose the regular waveforms such as Sine, Ramp, Square, Trapezia, DC, Exponent, AM/FM.

1. Push the GEN/DSO button to display the DDS Menu.



2. Press F1 or F2 softkey to select the desired waveform.
3. Press F3 softkey to set frequency.
4. Press F4 softkey to set amplitude.
5. Press F5 softkey to set offset.
6. Press F6 softkey to enter the second page.
7. Press F3 softkey to set the waveform parameter.
8. Press F1 or F2 softkey to set the burst type.
There are six types: EXT Low, EXT High, EXT Rise, EXT Fall, Single, and Continuous.
When you select Single burst type, press F4 to burst the waveform.

When you select AM/FM waveform, please set the waveform parameter as follows:

- Type: Select "AM" or "FM".
- F0: Set the carrier wave frequency.
- Depth: Set the wave Depth.
- Max Freq: Set the wave Max frequency deviation.

2.16.2 Edit Arbitrary Waveform

User can't edit arbitrary waveform directly under **Wave Gen** interface for the device. Firstly, please double click "WaveEditorSetup.exe" in WaveEditor folder in CD disk and install Arbitrary Waveform Editor software according to installation wizard. After the software installed successfully, you can see **WaveEditor** icon on desktop. Double-click the icon to enter arbitrary waveform generator window.



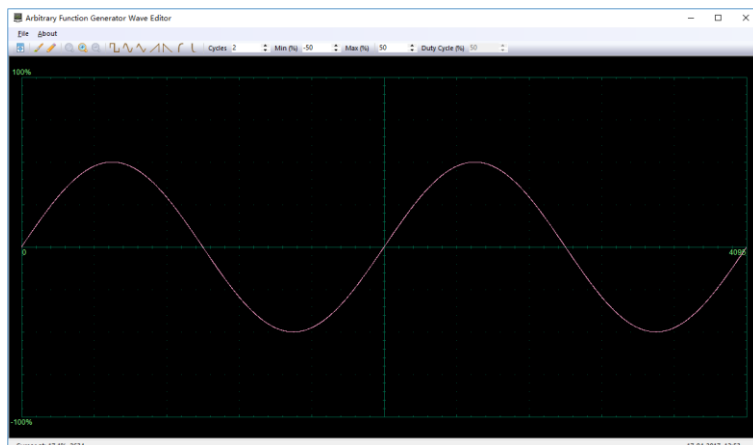

Menu:

Import from CSV: Import the CSV format file to the arbitrary waveform generator window.

Export as CSV: Save as CSV format file.

Import from ARB: Import the ARB format file to the arbitrary waveform generator window.

Export as ARB: Save as ARB format file.

Note: The device can recall ARB and CSV format file in USB disk.

Toolbar buttons



Download waveform data to the device.



Smooth Drawing Mode. You can draw any waveform shape using the left-mouse.



Line Drawing Mode. You can click on the waveform to draw a straight line from the previous point.



Zoom tools. To zoom the time axis in or out, click the **+** or **-** zoom button and then click on the waveform area. Click the **100%** button to restore the time axis to its original scale.



Standard waveform shapes. Draw a standard waveform with the settings specified in the numerical controls below the toolbar. The current waveform will be erased.

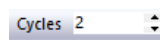

Cycles. The number of cycles to draw. This control is used in conjunction with the **Standard waveform shapes buttons**. Select one of the standard waveform shapes and then enter the number of cycles, and it will draw the requested number of cycles of the waveform.

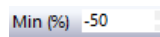

Minimum. When one of the **Standard waveform shapes buttons** is pressed, this control sets the minimum signal level.

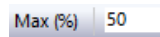

Maximum. When one of the **Standard waveform shapes buttons** is pressed, this control sets the maximum signal level.

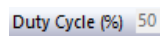

Duty cycle. When a square, triangular or ramp waveform is selected using one of the **Standard waveform shapes buttons**, this control sets the duty cycle of the signal. Duty cycle is defined as the time that the signal spends above zero volts divided by the total cycle time. Thus, a symmetrical square or triangular wave has a duty cycle of 50%. Reducing the duty

cycle shortens the positive part of the cycle and lengthens the negative part, and increasing the duty cycle does the opposite.

Note:

The **Frequency, Amplitude, Offset** parameter of the ARB waveform can not be regulated in this WaveEditor software, but it can be done by tuning on the device directly (refer to above Chapter 2.16.1) after the waveform data is downloaded to device (refer to below Chapter 2.16.3).

Do not use the WaveEditor and the DSO software at the same time, it will cause errors.

2.16.3 Output Arbitrary Waveform

1. Press the **GEN/DSO** button on the front panel to enter DDS function menu.
2. Press **GEN ON/GEN OFF** button on the front panel to enable the output function.
3. Connect the device with PC which has installed the WaveEditor software using a USB cable.
4. Double click the WaveEditor icon to open the program.
5. Select a waveform file or draw an arbitrary waveform; then click the  in toolbar and select waveform data download position to download waveform data to the device.

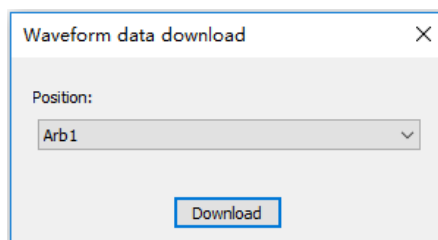

The waveform will output from GEN OUT BNC port.

Also, you can recall ARB format file in USB disk to output a waveform.

1. Press the **GEN/DSO** button on the front panel to enter DDS function menu.
2. Press **GEN ON/GEN OFF** button on the front panel to enable the output function.
3. Press **F1** or **F2** softkey to select Arb1~Arb4.
4. Press **F6** softkey twice to enter recall menu, and select desired recalled ARB and CSV format file in USB disk.
5. The waveform will output from GEN OUT BNC port.

2.17 Power Amplifier(Optional)

If users set the Power Amplifier Out to turn on, the power amplifier board will work in the instrument. When using the power amplifier, use a connecting cable to input the signal to the input terminal "GEN OUT", there will be a 2-time-amplified signal in the output terminal "2 time power amplifier output". The input signal should be the GEN OUT signal, not external signal.

Frequency Range

The frequency range of power amplifier is 10Hz~150kHz. Amplitude flatness within this frequency range is better than 3%, and sine distortion is better than 1%. The maximum testing frequency is up to 200kHz.

Output Power

The equation for output power of power amplifier is:

$$P=V^2/R$$

P is the output power, with the unit of W

V is the output amplitude RMS value, with the unit of Vrms

R is the load resistance, with the unit of Ω

The maximum output amplitude is up to 22Vpp (7.8Vrms). The minimum load resistance is 2 Ω . As the ambient temperature increases, the output signal frequency increases too. The lower output signal distortion is required, the smaller the max.output power is. Generally, the maximum output power can be up to 7W (8 Ω) or 1W (50 Ω).

Output Protection

The power amplifier has short circuit protection and over heat protection. It may not be burnt out in common operation. However, to prevent damage to power amplifier's performance, long time short circuit output should be avoided. Please also avoid to frequently using the maximum value of the frequency, amplitude and load.

Power Amp Out

Power Out: Turn on or turn off power amplifier out.

Chapter 3 Application Examples

This chapter unfolds a further description on main features of the oscilloscope by giving eleven simplified application examples for reference to help solve your own test problems.

1. [Taking simple measurements](#)
Using AUTOSET
Using the Measure menu to take auto measurements
2. [Taking cursor measurements](#)
Measuring ring frequency and ring amplitude
Measuring pulse width
Measuring rise time
3. [Analyzing input signals to eliminate random noise](#)
Observing a noisy signal
Eliminating random noise
4. [Capturing a single-shot signal](#)
5. [Using X-Y mode](#)
6. [Triggering on a pulse width](#)
7. [Triggering on a video signal](#)
Observing triggers on video fields and video lines
8. [Using Slope Trigger to capture a particular slope signal](#)
9. [Using Overtime Trigger to measure a long pulse signal](#)
10. [Using math functions to analyze waveforms](#)
11. [Measuring data propagation delay](#)

3.1 Example 1: Taking Simple Measurements

When you want to observe an unknown signal in a certain circuit without having its amplitude and frequency parameters, you may use this function to take a fast measurement on the frequency, period and peak-to-peak amplitude of the signal.

Follow the steps below.

1. Set the switch on the oscilloscope probe to 10X;
2. Push the CH1 MENU button and set the Probe option attenuation to 10X;
3. Connect the CH1 probe to the test point of the circuit;
4. Press the AUTOSET button.

The oscilloscope will automatically set the waveform to a best display. If you want to further optimize the waveform display, you may manually adjust the vertical and horizontal controls until the waveform meets your particular requirement.

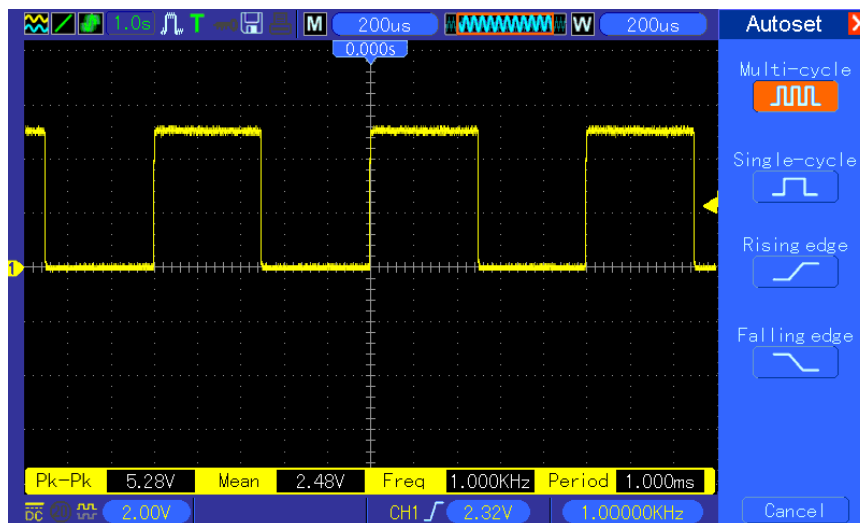

Taking Auto Measurements

The oscilloscope can display most signals by automatic measurements. To measure such parameters as the signal frequency, period, peak-to-peak amplitude, rise time and positive width, follow the steps below.

1. Push the MEASURE button to see the Measure menu.
2. Turn the knob V0 to select the first 'unspecified' option (marked by red arrow), press V0 or F6 to enter the submenu.
3. Select CH1 for the Source option. Then repeatedly push F3 or F4 to select measure items in the Type menu. Push the back menu to go back to the measure interface. Or turn and push V0 to select a measure item and go back to the measure interface. The corresponding box under the measure item shows the measurements.
4. Repeat Step 2 and Step 3. Then select other measure items. Totally 8 measure items can be displayed.

Note: All readouts change with the measured signals.

The figure below shows three measure items as an example. The boxes under them display the measurements in large fonts.

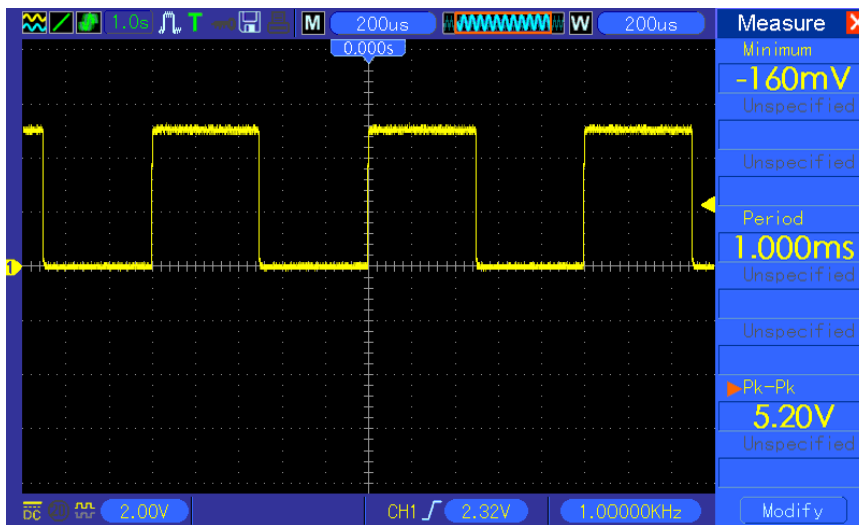

3.2 Example 2: Taking Cursor Measurements

You can use the cursor to quickly measure the time and amplitude of a waveform.

Measuring Ring Time (convertible to Frequency) and Amplitude on Rising Edge of Pulse

To measure the ring time on the rising edge of the pulse, follow the steps below.

1. Push the CURSOR button to view the Cursor menu.
2. Push F1 the Type option button and select Time.
3. Push F2 or F3 the Source option button and select CH1.
4. Push F4 to select a cursor. If S is selected, turn V0 to move Cursor S on the screen; if E is selected, turn V0 to move Cursor E; if both are selected, turn V0 to move them at the same time.
5. Put Cursor S on the first peak of the ring.
6. Put Cursor E on the second peak of the ring.
7. At Delta displays the measured time and at Cursor S an Cursor E display the positions of these two cursors.
8. Push the Type option button and select Voltage.
9. Put Cursor S on the highest peak of the ring.
10. Put Cursor E on the lowest point of the ring. The amplitude of the ring will be displayed at Delta.

See figures below for better understanding.

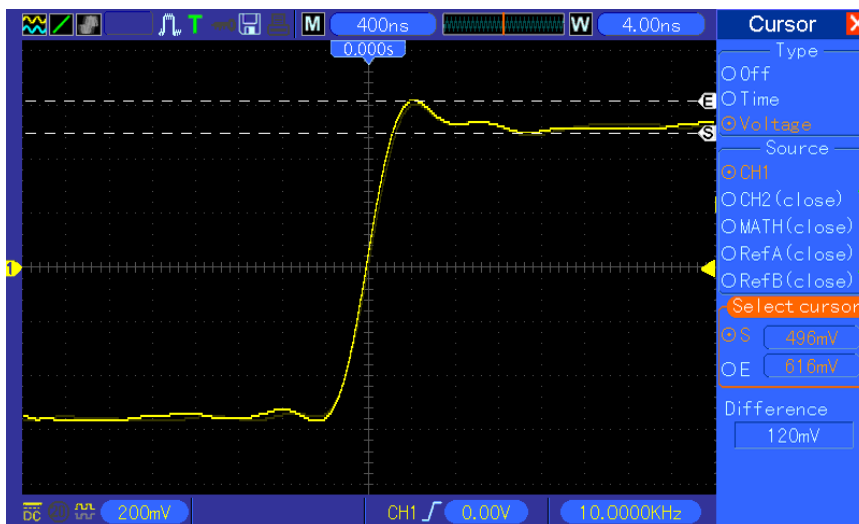
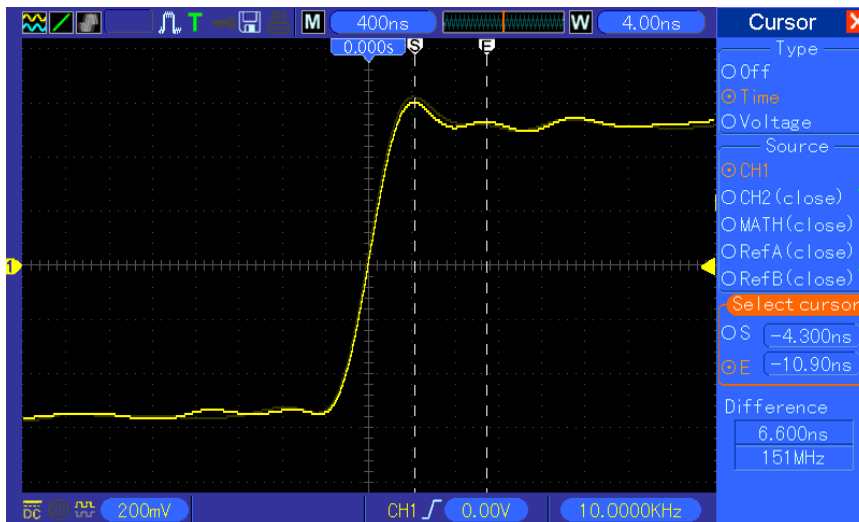

Measuring Pulse Width

To analyze a pulse signal and to know its width, follow the steps below.

1. Push the CURSOR button to view the Cursor menu.
2. Push F1 the Type option button and select Time.
3. Push F2 or F3 the Source option button and select CH1.
4. Push F4 to select a cursor. If S is selected, turn V0 to move Cursor S on the screen; if E is selected, turn V0 to move Cursor E; if both are selected, turn V0 to move them at the same time.
5. Place Cursor S on the rising edge of the pulse and Cursor E on the falling edge.
6. Thus at Delta displays the measured time and at Cursor S and Cursor E displays the time relative to the trigger.

See the figure below for better understanding.

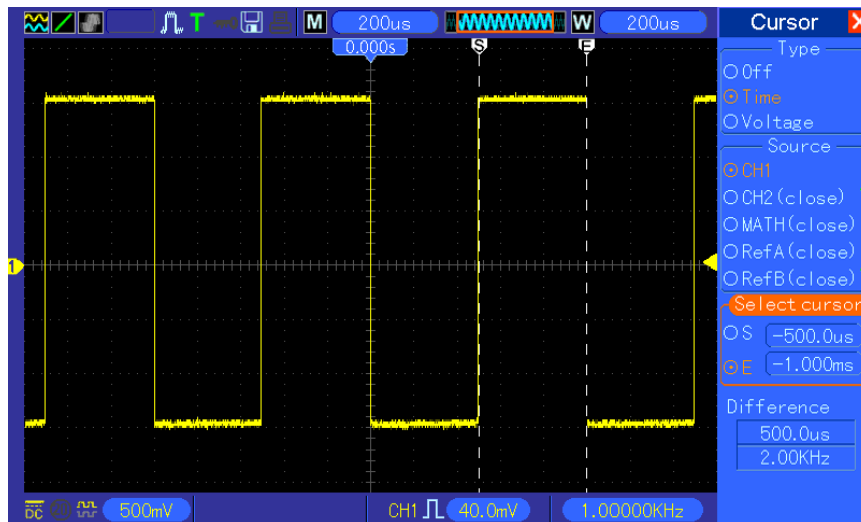

Measuring Rise Time of Pulse

You may need to measure the rise time of the pulse in many application environments, usually, to measure the rise time between the 10% and 90% levels of the pulse waveform. To do so, follow the steps below.

1. Turn the SEC/DIV knob to display the rising edge of the waveform.
2. Turn the VOLTS/DIV and VERTICAL POSITION knobs to adjust the waveform amplitude to about 5 divisions.
3. Push the CH1 MENU button.
4. Push the VOLTS/DIV option button and select Fine. Turn the VERTICAL POSITION knob to accurately separate the waveform into 5 divisions.
5. Turn the VERTICAL POSITION knob to center the waveform. Position the waveform baseline to 2.5 divisions below the center graticule.
6. Press the CURSOR button.
7. Push the Type option button and select Time. Push the Source option button to select CH1.
8. Select Cursor S and turn V0 to place it at the 10% level of the waveform.
9. Select Cursor E and turn V0 to place it at the 90% level of the waveform.
10. The Delta readout in the Cursor Menu is the rise time of the pulse.

See the figure below for better understanding.

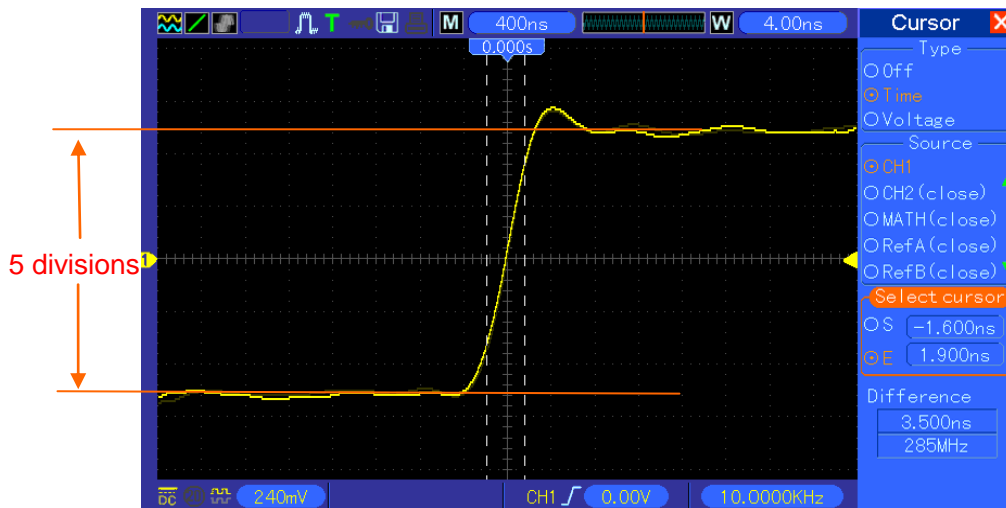

3.3 Example 3: Analyzing Input Signals to Eliminate Random Noise

In certain circumstances, to display a noisy signal on the oscilloscope and to get its details, you may follow the steps below to analyze this signal.

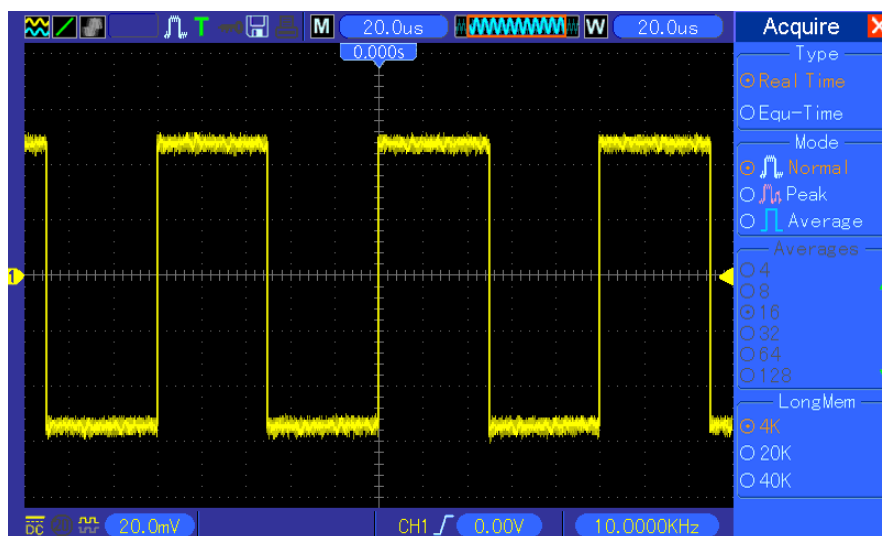

Observing Noisy Signal

1. Press the ACQUIRE button to see the Acquire menu.
2. Push the Type option button and select Real Time.
3. Push the Peak Detect option button.
4. If necessary, push the DISPLAY button and set the Contrast option to view the noise more clearly.

See the figure below for better understanding.

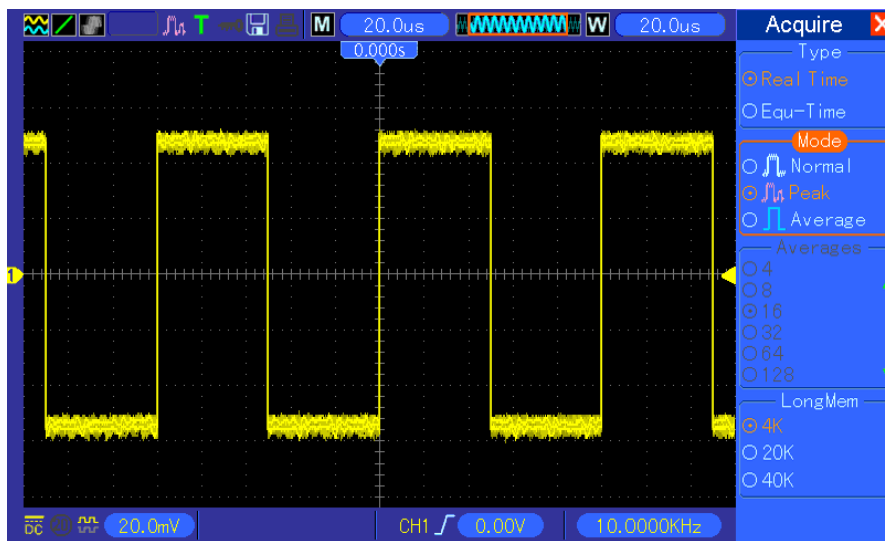

Eliminating Random Noise

1. Press the ACQUIRE button to see the Acquire menu.
2. Push the Type option button and select Real Time.
3. Push the Average option button.
4. Push the Averages option button and adjust the number of running averages to watch the change in the waveform display.

Note: *Averaging reduces random noise and let you view the signal details more easily.*

See the figure below for better understanding

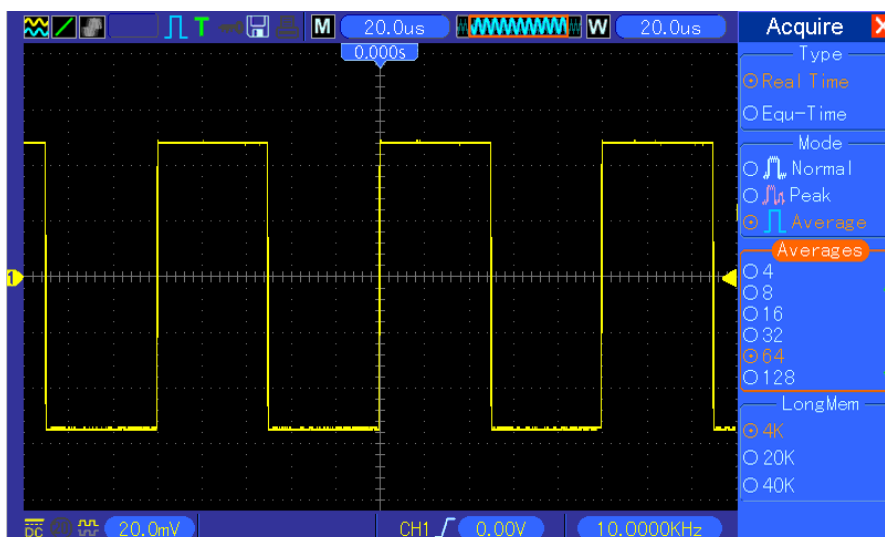

3.4 Example 4: Capturing Single-shot Signal

You may refer to the following example to easily capture some aperiodic signals like pulses and glitches.

To set for a single-shot acquisition, follow the steps below.

1. First, set up the oscilloscope probe and the attenuation factor of CH1.
2. Turn the vertical VOLTS/DIV and horizontal SEC/DIV knobs to a proper position for a better examination of the signal.
3. Press the ACQUIRE button to see the Acquire menu.
4. Push the Peak Detect option button.
5. Push the TRIG MENU button and select Rising for the Slope option. Then adjust the trigger level properly.
6. Push the SINGLE SEQ button to start the acquisition.

Using this feature can help you to capture occasional events more easily. This is an advantage of the digital storage oscilloscope.

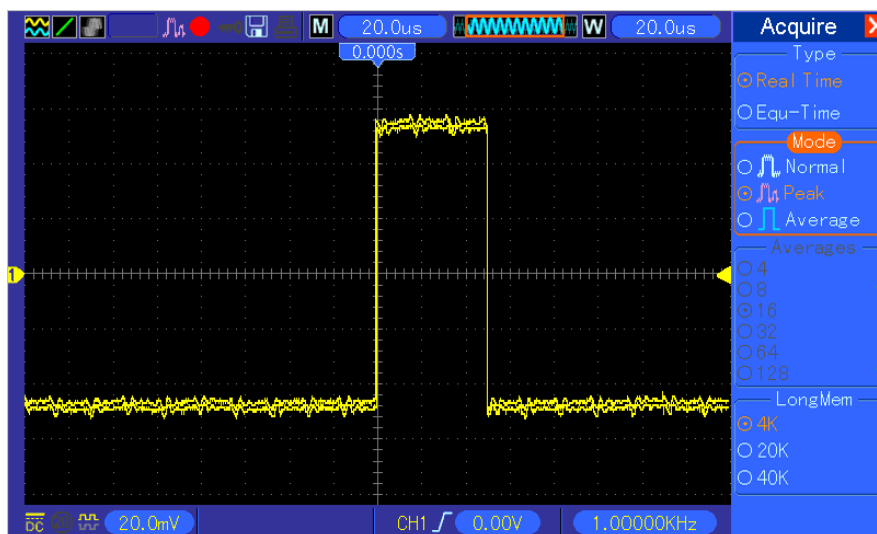

3.5 Example 5: Using X-Y Mode

Viewing Phase Differences between Two Channel Signals

For example, you need to measure the change in a phase across a circuit network.

Connect the oscilloscope with circuitry and view the input and output of the circuit in XY mode. Follow the steps below.

1. First, prepare two oscilloscope probes and set the switches to 10X on both probes.

2. Push the CH1 MENU button and set the Probe option attenuation to 10X; push the CH2 MENU button and set the Probe option attenuation to 10X.
3. Connect the CH1 probe to the input of the network, and connect the CH2 probe to the output.
4. Push the AUTOSSET button.
5. Turn the VOLTS/DIV knobs to display approximately the same amplitude signals on each channel.
6. Push the DISPLAY button to see the Display menu.
7. Push the Format option button and select XY.
8. Now the oscilloscope displays a Lissajous pattern to characterize the input and output of the circuit.
9. Turn the VOLTS/DIV and VERTICAL POSITION knobs to properly scale the waveform display.
10. Use the Lissajous's oscillographic method to observe and calculate the phase differences following the formula below.

As $\sin\theta = A/B$ or C/D , in which θ is the phase difference angle between channels and A, B, C, D represent what shown in the figure below, you can get the value of the phase difference angle by the formula: $\theta = \pm \arcsin(A/B)$ or $\pm \arcsin(C/D)$.

If the principal axes of the ellipse are in the first and third quadrants, the phase difference angle should be in the first and fourth quadrants, i.e. within $(0 \sim \pi/2)$ or $(3\pi/2 \sim 2\pi)$. If the principal axes of the ellipse are in the second and fourth quadrants, the phase difference angle should be in the second and third quadrants, i.e. within $(\pi/2 \sim \pi)$ or $(\pi - 3\pi/2)$. See the figure below for better understanding.

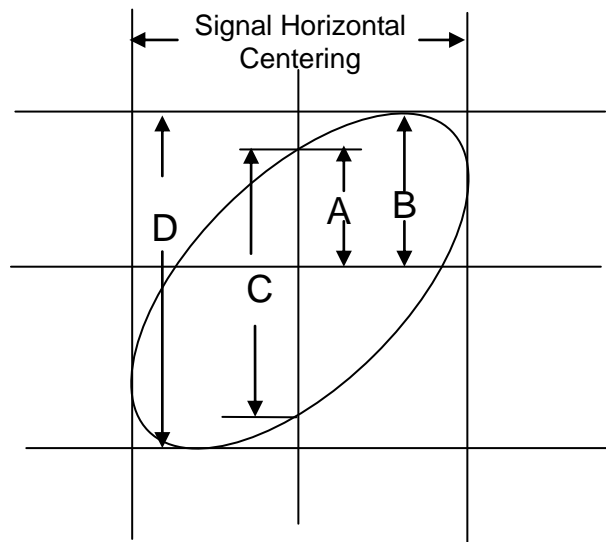

3.6 Example 6: Triggering on Pulse Width

Triggering on a Specific Pulse Width

While testing the pulse width of a signal in a circuit, you may need to verify the pulse width is consistent with the theoretic value. Or even if the edge triggering shows that your signal has the same pulse width with the specific signal, you still doubt about the result. Then you can follow the steps below.

1. Set the Probe option attenuation to 10X.
2. Push the AUTOSSET button to trigger a stable waveform display.
3. Push the Single Cycle option button in the Autoset menu and read out the signal pulse width.
4. Push the TRIG MENU button.
5. Push F1 to select Pulse for the Type option; push F2 to select CH1 for the Source option; turn the TRIGGER LEVEL knob to set the trigger level at the bottom of the signal.
6. Push F6 to enter the next page. Select the When option button and Push F4 to select '='.
7. Push the Set Pulse Width option button. Turn V0 to set the pulse width to the value read out in Step 3.
8. Turn the TRIGGER LEVEL knob to set the pulse width to the value read out in Step 3.
9. Push the More option button and select Normal for the Mode option. Once triggering on normal pulses, the oscilloscope can give a stable waveform display.
10. If the When option is set to $>$, $<$ or \neq and there appear any aberrant pulses that meet the specified condition, the oscilloscope will trigger. For example, the signal contains such aberrant pulses as shown below, you may select ' \neq ' or ' $<$ ' to trigger on the pulse.

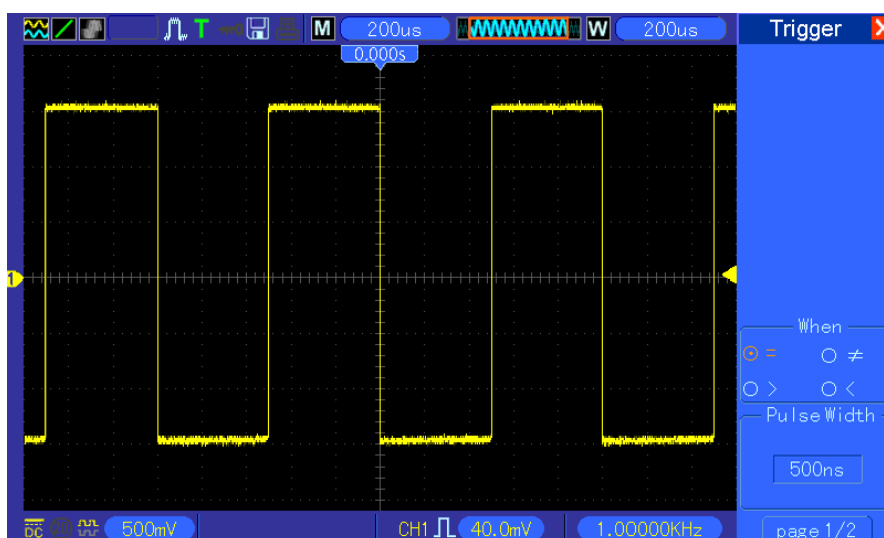

As shown in the above figure, you can get a stable waveform display if inputting a square wave at the frequency of 1KHz, with pulse width set to 500 μ s.

3.7 Example 7: Triggering on Video Signal

Assume that you are monitoring the video signals of a television to see if they are input normally, and the video signal is of an NTSC system. You can get a stable display by using the video trigger.

Triggering on Video Fields

To trigger on the video fields, follow the steps below.

1. Push the TRIG MENU button to see the Trigger menu.
2. Push F1 to select Video for the Type option.
3. Push the Source option button to select CH1; push the Polarity option button to select Normal; push the Standard option button to select NTSC.
4. Push the Sync option button to select Odd Field, Even Field or All Fields.
5. Turn the Trigger Level knob to adjust the trigger level and stabilize video signals.
6. Turn the horizontal SEC/DIV and the Vertical Position knobs to display on the screen a complete video signal triggering on a video field.

The figure below shows a stable signal triggering on a video field.

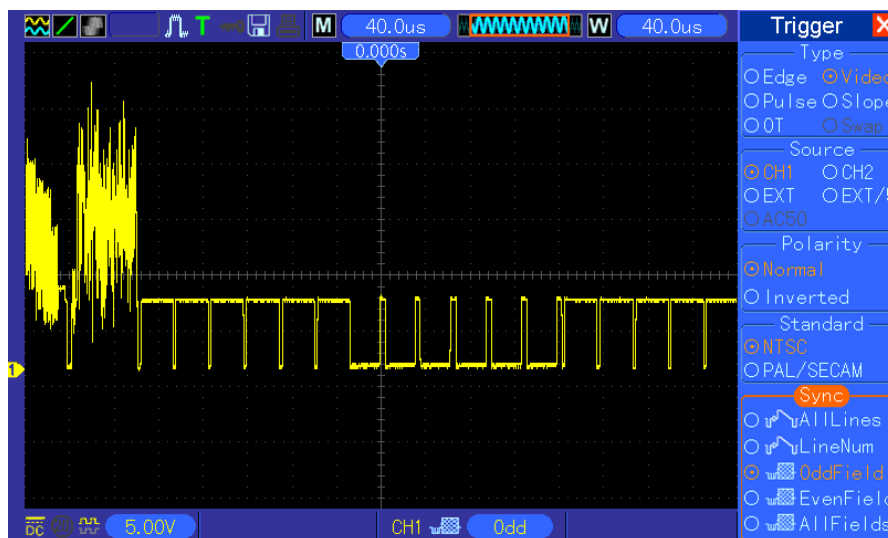

Triggering on Video Lines

To trigger on the video lines, follow the steps below.

1. Push the TRIG MENU button to see the Trigger menu.
2. Push F1 to select Video for the Type option.
3. Push the Source option button to select CH1; push the Polarity option button to select Normal; push the Standard option button to select NTSC; push the Sync option button to select Line Number.
4. Turn the Trigger Level knob to adjust the trigger level and stabilize video signals.

5. Turn V0 to adjust the line number (NTSC: 0-525 lines).
6. Turn the horizontal SEC/DIV and the vertical VOLTS/DIV knobs to display on the screen a complete video signal triggering on a video line. See the figure below.



3.8 Example 8: Using Slope Trigger to Capture Particular Slope Signal

In many occasions, we are not only concerned about the edge of the signal, but also want to know the rise and fall times of the signal. To better observe this kind of signals, we bring in the slope trigger. Follow the steps below.

1. Push the TRIG MENU button to see the Trigger menu.
2. Push F1 to select Slope for the Type option.
3. Push the Source option button to select CH1; push the Slope option button to select Rising; push the Mode option button to select Auto; push the Coupling option button to select DC.
4. Click the 'Next Page' button and select Vertical. Turn the V0 knob to adjust V1 and V2 to proper locations. Select the When option button and set it to '='.
5. Select 'Time' and turn V0 to adjust the time until you get a stable display of waveforms. See the figure below.

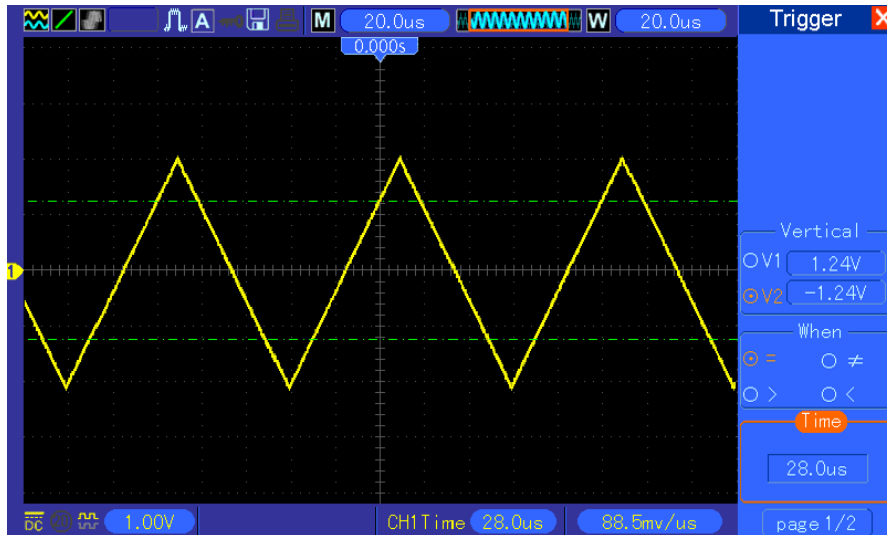

3.9 Example 9: Using Overtime Trigger to Measure Long Pulse Signal

Pulse Signal

It is not easy to observe some part of a long pulse signal by using the edge or pulse width trigger. In such case, you can use the overtime trigger by following steps.

1. Push the TRIG MENU button to see the Trigger menu.
2. Push F1 to select OT for the Type option; push the Polarity option button to select Normal; push the Mode option button to select Auto; push the Coupling option button to select DC.
3. Turn the Trigger Level knob to adjust the trigger level and stabilize video signals.
4. Turn V0 to adjust the line number (NTSC: 0-525 lines).
5. Turn the horizontal SEC/DIV and the vertical VOLTS/DIV knobs to display on the screen a complete video signal triggering on a video line. See the figure below.

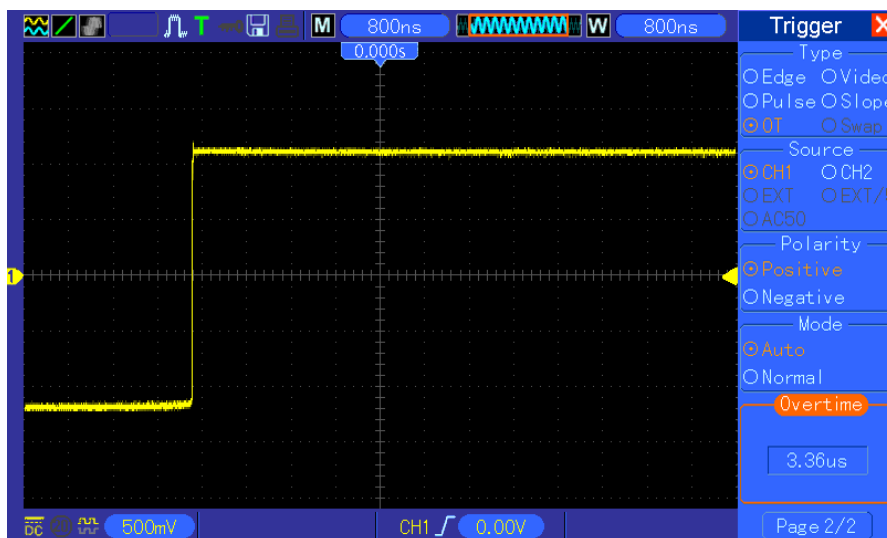

Note: The difference between the overtime and the delay triggers is that the overtime trigger can identify the pulse you need according to your set time and trigger on any point of the pulse. In the other word, the overtime trigger occurs based on pulse identification. It is similar to the > mode of the pulse width trigger, but not the same.

3.10 Example 10: Using Math Functions to Analyze Waveforms

Waveforms

Using math functions to analyze input waveforms is another advantage of the digital oscilloscope. For example, you want to get the instantaneous difference between two channel waveforms. By using the math function of the oscilloscope, you can get a better representation of the waveform on the screen. To observe this signal, follow the steps below.

1. Set the Probe option attenuation to 10X.
2. Open CH1 and CH2 at the same time, both with the attenuation of 10X.
3. Push the AUTOSSET button to trigger a stable waveform.
4. Push the MATH MENU button to see the Math menu.
5. Push the Operation option button and select 'CH1+CH2'.
6. Turn the horizontal SEC/DIV and the vertical VOLTS/DIV knobs to properly scale the waveform for easy check.

In addition, the oscilloscope also supports the - and FFT functions. For a detailed analysis on FFT, refer to [Chapter 2.7.2 Math FFT](#).

Note: You should compensate both probes before performing the math operation; otherwise, differences in probe compensation will appear as errors in the differential signal.

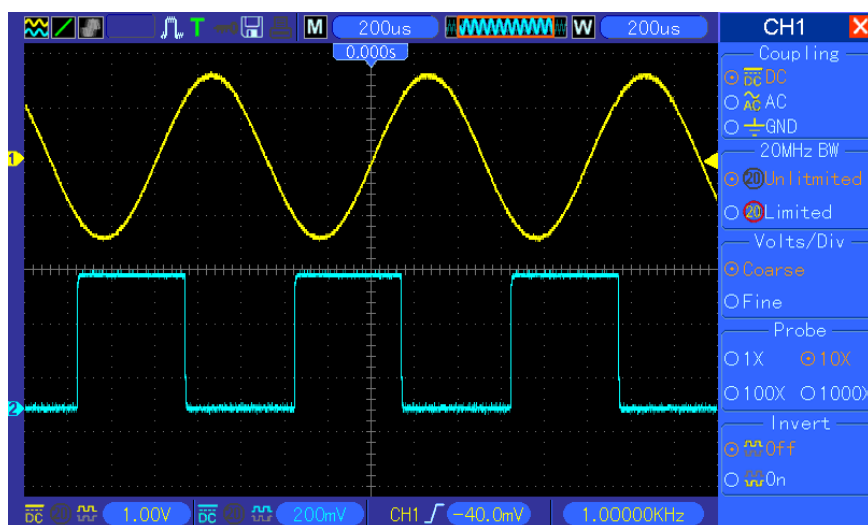

As illustrated in the above figure, input a 1KHz sine wave from CH1 and a 1KHz square wave from

CH2.

Follow the above steps to set up the Math menu, and observe the subtracted waveform as shown in the figure below.

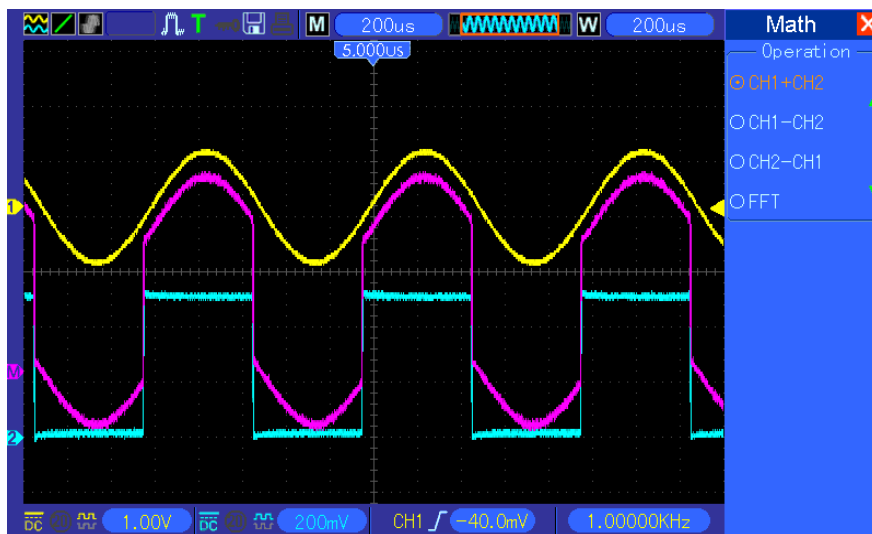

Those in pink are added waveforms.

3.11 Example 11: Measuring Data Propagation Delay

When you doubt that there appear instabilities in a serial data propagation control circuit, you can set the oscilloscope to measure the propagation delay between the enable signal and the transfer data.

To set the propagation delay measurement, follow the steps below.

1. Connect two oscilloscope probes respectively to the CS (chip-select) pin and the DATA pin on the chip.
2. Set the Probe option attenuation to 10X for both probes.
3. Open CH1 and CH2 at the same time, both with the attenuation of 10X.
4. Push the AUTOSET button to trigger a stable waveform display.
5. Adjust the horizontal and vertical controls to optimize the waveform display.
6. Push the CURSOR button to view the Cursor menu.
7. Push the Type option button and select Time.
8. Select Cursor S and turn V0 to place it on the active edge of the enable signal.
9. Select Cursor E and turn V0 to place it on the data output transition (See the figure below).
10. Read the data propagation delay in the Delta readout.

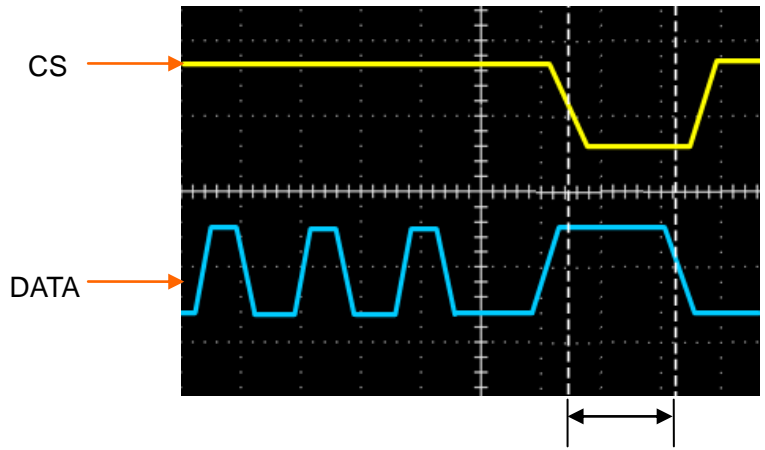
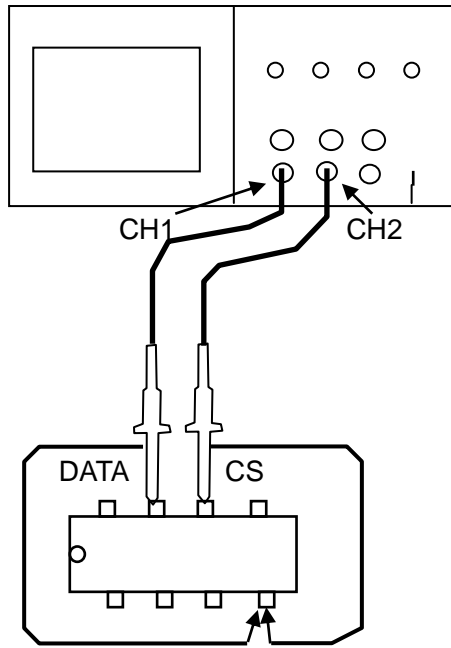

Chapter 4 Troubleshooting

4.1 Problem Settlement

1. If the oscilloscope does not start up at power on, follow these steps:

- 1) Check the power cord to verify it has been connected properly;
- 2) Check the power on/off button to ensure it has been pushed;
- 3) Then restart the oscilloscope.

2. If there is no display of waveforms on the screen when the oscilloscope is turned on, follow these steps:

- 1) Check the probe to assure its proper connection to the input BNC;
- 2) Check the channel switch (such as CH1, CH2 menu buttons) to make sure it has been turned on;
- 3) Check the input signal to verify it has been connected to the probe correctly;
- 4) Affirm that all measured circuits have signals to output;
- 5) Turn up the magnitude for DC signals with large magnitude;
- 6) In addition, you may press the Auto Measure button to perform an automatic detection of signals at first.

3. If the waveform of the input signal is distorted seriously, follow these steps:

- 1) Check the probe to assure its proper connection to the channel BNC;
- 2) Check the probe to assure its good connection to the measured object;
- 3) Check the probe to verify it has been well calibrated. Otherwise, refer to the content about calibration described in this manual.

4. If the waveform is rolling continuously on the screen but can not be triggered, follow these steps:

- 1) Check the trigger source to make sure it consistent with the input channel;
- 2) Check the trigger level to assure its correct adjustment. You may push the TRIGGER LEVEL knob or press the SET TO 50% button to reset the trigger level back to the center of the signal;
- 3) Check the trigger mode to confirm it is a right choice for the input signal. The default trigger mode is edge trigger. However, it is not suitable for all kinds of input signals.

Chapter 5 Specifications

5.1 Technical Specifications

All specifications herein mentioned apply to the DSO4000 series oscilloscopes. Before checking an oscilloscope from your seller to see if it complies with these specifications, make sure it meets the following conditions:

- The oscilloscope must have been operating continuously for twenty minutes under the specified operating temperature.
- The Do Self Cal operation must be performed through the Utility menu if the operating temperature changes by more than 5°C.
- The oscilloscope must be within the factory calibration interval.

All specifications are guaranteed unless noted 'typical'.

Oscilloscope Specifications

Horizontal

Sample Rate Range	1GS/s	
Waveform Interpolation	(sin x)/x	
Record Length	Maximum 40K samples per single-channel; maximum 20K samples per dual-channel (4K, 20K optional)	
SEC/DIV Range	2ns/div to 40s/div, in a 2, 4, 8 sequence	
Sample Rate and Delay Time Accuracy	±50ppm over any ≥1ms time interval	
Delta Time Measurement Accuracy (Full Bandwidth)	Single-shot, Normal mode ± (1 sample interval + 100ppm × reading + 0.6ns)	
	>16 averages ± (1 sample interval + 100ppm × reading + 0.4ns)	
	Sample interval = s/div ÷ 200	
Position Range	2ns/div to 8ns/div	(-8div × s/div) to 20ms
	20ns/div to 80µs/div	(-8div × s/div) to 40ms
	200µs/div to 40s/div	(-8div × s/div) to 400s

Vertical

A/D Converter	8-bit resolution, each channel sampled simultaneously
VOLTS/DIV Range	2mV/div to 10V/div at input BNC

Offset Range	2mV/div to 20mV/div, $\pm 400\text{mV}$ 50mV/div to 200mV/div, $\pm 2\text{V}$ 500mV/div to 2V/div, $\pm 40\text{V}$ 5V/div to 10V/div, $\pm 50\text{V}$		
Selectable Analog Bandwidth Limit, typical	20MHz		
Low Frequency Response (-3db)	$\leq 10\text{Hz}$ at BNC		
Rise Time at BNC, typical	DSO4072	DSO4102	DSO4202
	$\leq 5.0\text{ns}$	$< 3.5\text{ns}$	$< 1.8\text{ns}$
DC Gain Accuracy	$\pm 3\%$ for Normal or Average acquisition mode, 10V/div to 10mV/div		
	$\pm 4\%$ for Normal or Average acquisition mode, 5mV/div to 2mV/div		
DC Measurement Accuracy, Average Acquisition Mode	Measurement Type: Average of ≥ 16 waveforms with vertical position at zero Accuracy: $\pm (3\% \times \text{reading} + 0.1\text{div} + 1\text{mV})$ when 10mV/div or greater is selected		
	Measurement Type: Average of ≥ 16 waveforms with vertical position not at zero Accuracy: $\pm [3\% \times (\text{reading} + \text{vertical position}) + 1\% \text{ of vertical position} + 0.2\text{div}]$ Add 2mV for settings from 2mV/div to 200mV/div; add 50mV for settings from 200mV/div to 10V/div		
Volts Measurement Repeatability, Average Acquisition Mode	Delta volts between any two averages of ≥ 16 waveforms acquired under same setup and ambient conditions		

Note: Bandwidth reduced to 6MHz when using a 1X probe.

Trigger

Trigger Sensitivity (Edge Trigger Type)	Coupling	Sensitivity		
	DC	Source	DSO4072, DSO4102	DSO4202
		CH1 CH2	1div from DC to 10MHz; 1.5div from 10MHz to Full	1.5div from 10MHz to 100MHz; 2div from 100MHz to Full
		EXT	200mV from DC to 100MHz	200mV from DC to 100MHz; 350mV from 100MHz to 200MHz
		EXT/5	1V from DC to 100MHz	1V from DC to 100MHz; 1.75V from 100MHz to 200MHz
	AC	Attenuates signals below 10Hz		
HF Reject	Attenuates signals above 80kHz			

	LF Reject	Same as the DC-coupled limits for frequencies above 150kHz; attenuates signals below 150kHz
Trigger Level Range	Source	Range
	CH1, CH2	± 8 divisions from center of screen
	EXT	$\pm 1.2V$
	EXT/5	$\pm 6V$
Trigger Level Accuracy, typical (Accuracy is for signals having rise and fall times $\geq 20ns$)	Source	Accuracy
	CH1, CH2	$0.2div \times volts/div$ within ± 4 divisions from center of screen
	EXT	$\pm (6\% \text{ of setting} + 40mV)$
	EXT/5	$\pm (6\% \text{ of setting} + 200mV)$
Set Level to 50%, typical	Operates with input signals $\geq 50Hz$	

Note: Bandwidth reduced to 6MHz when using a 1X probe.

Video Trigger Type	Source	Range
	CH1, CH2	Peak-to-peak amplitude of 2 divisions
	EXT	400mV
	EXT/5	2V
Signal Formats and Field Rates, Video Trigger Type	Supports NTSC, PAL and SECAM broadcast systems for any field or any line	
Holdoff Range	100ns to 10s	
Pulse Width Trigger		
Pulse Width Trigger Mode	Trigger when < (Less than), > (Greater than), = (Equal), or \neq (Not Equal); Positive pulse or Negative pulse	
Pulse Width Trigger Point	<p>Equal: The oscilloscope triggers when the trailing edge of the pulse crosses the trigger level.</p> <p>Not Equal: If the pulse is narrower than the specified width, the trigger point is the trailing edge. Otherwise, the oscilloscope triggers when a pulse continues longer than the time specified as the Pulse Width.</p> <p>Less than: The trigger point is the trailing edge.</p> <p>Greater than (also called overtime trigger): The oscilloscope triggers when a pulse continues longer than the time specified as the Pulse Width.</p>	
Pulse Width Range	Selectable from 20ns to 10s	
Slope Trigger		
Slope Trigger Mode	Trigger when < (Less than), > (Greater than), = (Equal), or \neq (Not Equal); Positive slope or Negative slope	
Slope Trigger Point	<p>Equal: The oscilloscope triggers when the waveform slope is equal to the set slope.</p> <p>Not Equal: The oscilloscope triggers when the waveform slope is not equal to the set slope.</p>	

	Less than: The oscilloscope triggers when the waveform slope is less than the set slope. Greater than: The oscilloscope triggers when the waveform slope is greater than the set slope.
Time Range	Selectable from 20ns to 10s
Overtime Trigger	The leading edge: Rising edge or Falling edge; Time Setting: 20-10s
Swap Trigger	
CH1	Internal Trigger: Edge, Pulse Width, Video, Slope
CH2	Internal Trigger: Edge, Pulse Width, Video, Slope
Trigger Frequency Counter	
Readout Resolution	6 digits
Accuracy (typical)	± 30 ppm (including all frequency reference errors and ± 1 count errors)
Frequency Range	AC coupled, from 4Hz minimum to rated bandwidth
Signal Source	Pulse Width or Edge Trigger modes: all available trigger sources The Frequency Counter measures trigger source at all times, including when the oscilloscope acquisition pauses due to changes in the run status, or acquisition of a single shot event has completed. Pulse Width Trigger mode: The oscilloscope counts pulses of significant magnitude inside the 1s measurement window that qualify as triggerable events, such as narrow pulses in a PWM pulse train if set to < mode and the width is set to a relatively small time. Edge Trigger mode: The oscilloscope counts all edges of sufficient magnitude and correct polarity. Video Trigger mode: The Frequency Counter does not work.

Acquisition

Acquisition Modes	Normal, Peak Detect, and Average	
Acquisition Rate, typical	Up to 2000 waveforms per second per channel (Normal acquisition mode, no measurement)	
Single Sequence	Acquisition Mode	Acquisition Stop Time
	Normal, Peak Detect	Upon single acquisition on all channels simultaneously
	Average	After N acquisitions on all channels simultaneously, N can be set to 4, 8, 16, 32, 64 or 128

Inputs

Inputs	
Input Coupling	DC, AC or GND
Input Impedance, DC coupled	$1\text{M}\Omega \pm 2\%$ in parallel with $20\text{pF} \pm 3\text{pF}$
Probe Attenuation	1X, 10X

Supported Probe Attenuation Factors	1X, 10X, 100X, 1000X	
Maximum Input Voltage	Overvoltage Category	Maximum Voltage
	CAT I and CAT II	300V _{RMS} (10×), Installation Category
	CAT III	150V _{RMS} (1×)
	Installation Category II: derate at 20dB/decade above 100kHz to 13V peak AC at 3MHz* and above. For non-sinusoidal waveforms, peak value must be less than 450V. Excursion above 300V should be of less than 100ms duration. RMS signal level including all DC components removed through AC coupling must be limited to 300V. If these values are exceeded, damage to the oscilloscope may occur.	

Measurements

Cursors	Voltage difference between cursors: ΔV Time difference between cursors: ΔT Reciprocal of ΔT in Hertz ($1/\Delta T$)
Automatic Measurements	Frequency, Period, Mean, Peak-to-peak, Cycle RMS, PRMS, Minimum, Maximum, Rise Time, Fall Time, + Width, - Width, + Duty, - Duty, Base, Top, Middle, Amplitude, Overshoot, Preshoot, Pmean, FOVShoot, RPREShoot, BWidth, Delay 1-2 ↑, Delay 1-2 ↓, LFF, LFR, LRF, LRR, FFR, EFRF

General Specifications

Display	
Display Type	7 inch 64K color TFT (diagonal liquid crystal)
Display Resolution	800 horizontal by 480 vertical pixels
Display Contrast	Adjustable (16 gears) with the progress bar
Probe Compensator Output	
Output Voltage, typical	About 5Vpp into $\geq 1M\Omega$ load
Frequency, typical	1kHz
Power Supply	
Supply Voltage	100-120VAC _{RMS} ($\pm 10\%$), 45Hz to 440Hz, CAT II 120-240VAC _{RMS} ($\pm 10\%$), 45Hz to 66Hz, CAT II
Power Consumption	<30W
Fuse	2A, T rating, 250V
Environmental	
Temperature	Operating: 32°F to 122°F (0°C to 50°C)
	Nonoperating: -40°F to 159.8°F (-40°C to +71°C)
Cooling Method	Convection
Humidity	+104°F or below (+40°C or below): $\leq 90\%$ relative humidity
	106°F to 122°F (+41°C to 50°C): $\leq 60\%$ relative humidity

Altitude	Operating and Nonoperating	3,000m (10,000 feet)
	Random Vibration	0.31g _{RMS} from 50Hz to 500Hz, 10 minutes on each axis
	Nonoperating	2.46g _{RMS} from 5Hz to 500Hz, 10 minutes on each axis
Mechanical Shock	Operating	50g, 11ms, half sine
Mechanical		
Size	Length	313mm
	Height	142mm
	Depth	108mm
Weight	exclusive of packing and accessories	2.08Kg

Arbitrary Waveform Generator Mode

Waveform Frequency	Sine wave: 1Hz~25MHz (-3dB) Square wave: 1Hz~5MHz Ramp wave 1Hz~10MHz Trapezium wave 1Hz~5MHz AM/FM wave 1Hz~5MHz Arbitrary wave: 1Hz~25MHz. Exponent wave: 1Hz~900KHz
DAC	2K~200MHz adjustable
Frequency Resolution	0.10%
Channel	1CH waveform output
Waveform Depth	2KSa
Vertical Resolution	12 bit
Frequency Stability	<30ppm
Wave Amplitude	±3.5V Max.
Output Impedance	50 Ω
Output Current	50mA, I _{peak} =50mA
System BW	25M
Harmonic Distortion	-50dBc(1KHz), -40dBc(10KHz)





Power Amplifier(Optional)

Maximum power output	7W(8 Ω), 1W(50 Ω)
Maximum output voltage	22V _{pp}
Frequency bandwidth	1Hz~200KHz

5.2 Accessories

All the following accessories are available.

Standard Accessories

Sketch	Description
	X1, X10 two passive probes. The passive probes have a 6MHz bandwidth (rated 100Vrms CAT III) when the switch is in the X1 position, and a maximum bandwidth (rated 300Vrms CAT II) when the switch is in the X10 position. Each probe consists of all necessary fittings.
	A USB A-B line, used to connect external devices with USB-B interface like a printer or to establish communications between PC and the oscilloscope.
	A power cord special for this product. In addition to the power cord shipped with your instrument, you may purchase another one certified for the country of use.
	A software installation CD. It contains the user manual of DSO4000, giving particular descriptions on the DSO4000 series oscilloscopes. *. To this digital storage oscilloscope, the PC software is not important, no more advanced functions are developed. For example, 1. For the function of "export into Excel format", there is already "Save into CSV" function on the oscilloscope 2. Export is only possible with BMP format, etc.

5.3 Open Source Information

General Information:

Kernel Version	Linux3.2.35
Supported File system	Yaffs, Fat32
Drivers	Buzzer Driver, DMA Driver, FPGA Driver, I2C Driver, SPI Driver, IO-bank Driver, USB Host Driver, LCD Driver, USB massstorage、gadget Driver
Linux Applications	busybox1.18.4, gnupg1.4.11
U_boot Version	Vivi_3.2.35

License: GPLv2 See Appendix B

Chapter 6 General Care and Cleaning

6.1 General Care

Do not put or leave the device in a place where the LCD display will be exposed to direct sunlight for long periods of time.

Note: To avoid damage to the oscilloscope or probes, do not expose them to sprays, liquids, or solvents.

6.2 Cleaning

Examine the oscilloscope and probes as often as operating conditions require. To clean the exterior surface, perform the following steps:

- 1) Use a lint-free cloth to remove floating dust on the outside of the oscilloscope and probes. Take care to avoid scratching the glabrous display filter.
- 2) Use a soft cloth dampened with water to clean the oscilloscope. For more efficient cleaning, you may use an aqueous solution of 75% isopropyl alcohol.

Note: *To avoid damage to the surface of the oscilloscope or probes, do not use any corrosive or chemical cleaning agents.*

Appendix A Harmful and Poisonous Substances or Elements

Component ²	Harmful and poisonous substances or elements ¹					
	Pb	Hg	Cd	Cr(Vi)	PBB	PBDE
Shell and Chassis	X	0	0	X	0	0
Display Module	X	X	0	0	0	0
Circuit Board	X	0	0	X	0	0
Power Supply	X	0	0	X	0	0
Electric Wire and Cable Assembly	X	0	0	0	0	0
Connector	X	0	0	X	0	0
Fastener and Installed Hardware	X	0	X	X	0	0
Other Accessories (including probes)	X	0	0	X	0	0
Others	0	0	0	0	0	0

'X' means that at least the content of this poisonous and harmful substance in a homogeneous material of this component exceeds the limit specified in the SJ/T 11363-2006 standard.

'0' indicates that the content of this poisonous and harmful substance in all homogeneous materials of this component is refrained under the limit stated in the SJ/T 11363-2006 standard.

This component list contains components approved in the file '*Management Measures*'.

Appendix B

GNU GENERAL PUBLIC LICENSE

Version 2, June 1991

Copyright (C) 1989, 1991 Free Software Foundation, Inc.,
51 Franklin Street, Fifth Floor, Boston, MA 02110-1301 USA

Everyone is permitted to copy and distribute verbatim copies of this license document, but changing it is not allowed.

Preamble

The licenses for most software are designed to take away your freedom to share and change it. By contrast, the GNU General Public License is intended to guarantee your freedom to share and change free software--to make sure the software is free for all its users. This General Public License applies to most of the Free Software Foundation's software and to any other program whose authors commit to using it. (Some other Free Software Foundation software is covered by the GNU Lesser General Public License instead.) You can apply it to your programs, too.

When we speak of free software, we are referring to freedom, not price. Our General Public Licenses are designed to make sure that you have the freedom to distribute copies of free software (and charge for this service if you wish), that you receive source code or can get it if you want it, that you can change the software or use pieces of it in new free programs; and that you know you can do these things.

To protect your rights, we need to make restrictions that forbid anyone to deny you these rights or to ask you to surrender the rights. These restrictions translate to certain responsibilities for you if you distribute copies of the software, or if you modify it.

For example, if you distribute copies of such a program, whether gratis or for a fee, you must give the recipients all the rights that you have. You must make sure that they, too, receive or can get the source code. And you must show them these terms so they know their rights.

We protect your rights with two steps: (1) copyright the software, and (2) offer you this license which gives you legal permission to copy, distribute and/or modify the software.

Also, for each author's protection and ours, we want to make certain that everyone understands that there is no warranty for this free software. If the software is modified by someone else and

passed on, we want its recipients to know that what they have is not the original, so that any problems introduced by others will not reflect on the original authors' reputations.

Finally, any free program is threatened constantly by software patents. We wish to avoid the danger that redistributors of a free program will individually obtain patent licenses, in effect making the program proprietary. To prevent this, we have made it clear that any patent must be licensed for everyone's free use or not licensed at all.

The precise terms and conditions for copying, distribution and modification follow.

GNU GENERAL PUBLIC LICENSE TERMS AND CONDITIONS FOR COPYING, DISTRIBUTION AND MODIFICATION

0. This License applies to any program or other work which contains a notice placed by the copyright holder saying it may be distributed under the terms of this General Public License. The "Program", below, refers to any such program or work, and a "work based on the Program" means either the Program or any derivative work under copyright law: that is to say, a work containing the Program or a portion of it, either verbatim or with modifications and/or translated into another language. (Hereinafter, translation is included without limitation in the term "modification".) Each licensee is addressed as "you".

Activities other than copying, distribution and modification are not covered by this License; they are outside its scope. The act of running the Program is not restricted, and the output from the Program is covered only if its contents constitute a work based on the Program (independent of having been made by running the Program). Whether that is true depends on what the Program does.

1. You may copy and distribute verbatim copies of the Program's source code as you receive it, in any medium, provided that you conspicuously and appropriately publish on each copy an appropriate copyright notice and disclaimer of warranty; keep intact all the notices that refer to this License and to the absence of any warranty; and give any other recipients of the Program a copy of this License along with the Program.

You may charge a fee for the physical act of transferring a copy, and you may at your option offer warranty protection in exchange for a fee.

2. You may modify your copy or copies of the Program or any portion of it, thus forming a work based on the Program, and copy and distribute such modifications or work under the terms of Section 1 above, provided that you also meet all of these conditions:

a) You must cause the modified files to carry prominent notices stating that you changed the files and the date of any change.

b) You must cause any work that you distribute or publish, that in whole or in part contains or is derived from the Program or any part thereof, to be licensed as a whole at no charge to all third parties under the terms of this License.

c) If the modified program normally reads commands interactively when run, you must cause it, when started running for such interactive use in the most ordinary way, to print or display an announcement including an appropriate copyright notice and a notice that there is no warranty (or else, saying that you provide a warranty) and that users may redistribute the program under these conditions, and telling the user how to view a copy of this License. (Exception: if the Program itself is interactive but does not normally print such an announcement, your work based on the Program is not required to print an announcement.)

These requirements apply to the modified work as a whole. If identifiable sections of that work are not derived from the Program, and can be reasonably considered independent and separate works in themselves, then this License, and its terms, do not apply to those sections when you distribute them as separate works. But when you distribute the same sections as part of a whole which is a work based on the Program, the distribution of the whole must be on the terms of this License, whose permissions for other licensees extend to the entire whole, and thus to each and every part regardless of who wrote it.

Thus, it is not the intent of this section to claim rights or contest your rights to work written entirely by you; rather, the intent is to exercise the right to control the distribution of derivative or collective works based on the Program.

In addition, mere aggregation of another work not based on the Program with the Program (or with a work based on the Program) on a volume of a storage or distribution medium does not bring the other work under the scope of this License.

3. You may copy and distribute the Program (or a work based on it, under Section 2) in object code or executable form under the terms of Sections 1 and 2 above provided that you also do one of the following:

a) Accompany it with the complete corresponding machine-readable source code, which must be distributed under the terms of Sections 1 and 2 above on a medium customarily used for software interchange; or,

b) Accompany it with a written offer, valid for at least three years, to give any third party, for a charge no more than your cost of physically performing source distribution, a complete machine-readable copy of the corresponding source code, to be distributed under the terms of Sections 1 and 2 above on a medium customarily used for software interchange; or,

c) Accompany it with the information you received as to the offer to distribute corresponding source code. (This alternative is allowed only for noncommercial distribution and only if you

received the program in object code or executable form with such an offer, in accord with Subsection b above.)

The source code for a work means the preferred form of the work for making modifications to it. For an executable work, complete source code means all the source code for all modules it contains, plus any associated interface definition files, plus the scripts used to control compilation and installation of the executable. However, as a special exception, the source code distributed need not include anything that is normally distributed (in either source or binary form) with the major components (compiler, kernel, and so on) of the operating system on which the executable runs, unless that component itself accompanies the executable.

If distribution of executable or object code is made by offering access to copy from a designated place, then offering equivalent access to copy the source code from the same place counts as distribution of the source code, even though third parties are not compelled to copy the source along with the object code.

4. You may not copy, modify, sublicense, or distribute the Program except as expressly provided under this License. Any attempt otherwise to copy, modify, sublicense or distribute the Program is void, and will automatically terminate your rights under this License. However, parties who have received copies, or rights, from you under this License will not have their licenses terminated so long as such parties remain in full compliance.

5. You are not required to accept this License, since you have not signed it. However, nothing else grants you permission to modify or distribute the Program or its derivative works. These actions are prohibited by law if you do not accept this License. Therefore, by modifying or distributing the Program (or any work based on the Program), you indicate your acceptance of this License to do so, and all its terms and conditions for copying, distributing or modifying the Program or works based on it.

6. Each time you redistribute the Program (or any work based on the Program), the recipient automatically receives a license from the original licensor to copy, distribute or modify the Program subject to these terms and conditions. You may not impose any further restrictions on the recipients' exercise of the rights granted herein. You are not responsible for enforcing compliance by third parties to this License.

7. If, as a consequence of a court judgment or allegation of patent infringement or for any other reason (not limited to patent issues), conditions are imposed on you (whether by court order, agreement or otherwise) that contradict the conditions of this License, they do not excuse you from the conditions of this License. If you cannot distribute so as to satisfy simultaneously your obligations under this License and any other pertinent obligations, then as a consequence you may not distribute the Program at all. For example, if a patent license would not permit royalty-free redistribution of the Program by all those who receive copies directly or indirectly through you, then the only way you could satisfy both it and this License would be to refrain entirely from distribution of the Program.

If any portion of this section is held invalid or unenforceable under any particular circumstance, the balance of the section is intended to apply and the section as a whole is intended to apply in other circumstances.

It is not the purpose of this section to induce you to infringe any patents or other property right claims or to contest validity of any such claims; this section has the sole purpose of protecting the integrity of the free software distribution system, which is implemented by public license practices. Many people have made generous contributions to the wide range of software distributed through that system in reliance on consistent application of that system; it is up to the author/donor to decide if he or she is willing to distribute software through any other system and a licensee cannot impose that choice.

This section is intended to make thoroughly clear what is believed to be a consequence of the rest of this License.

8. If the distribution and/or use of the Program is restricted in certain countries either by patents or by copyrighted interfaces, the original copyright holder who places the Program under this License may add an explicit geographical distribution limitation excluding those countries, so that distribution is permitted only in or among countries not thus excluded. In such case, this License incorporates the limitation as if written in the body of this License.

9. The Free Software Foundation may publish revised and/or new versions of the General Public License from time to time. Such new versions will be similar in spirit to the present version, but may differ in detail to address new problems or concerns.

Each version is given a distinguishing version number. If the Program specifies a version number of this License which applies to it and "any later version", you have the option of following the terms and conditions either of that version or of any later version published by the Free Software Foundation. If the Program does not specify a version number of this License, you may choose any version ever published by the Free Software Foundation.

10. If you wish to incorporate parts of the Program into other free programs whose distribution conditions are different, write to the author to ask for permission. For software which is copyrighted by the Free Software Foundation, write to the Free Software Foundation; we sometimes make exceptions for this. Our decision will be guided by the two goals of preserving the free status of all derivatives of our free software and of promoting the sharing and reuse of software generally.

NO WARRANTY

11. BECAUSE THE PROGRAM IS LICENSED FREE OF CHARGE, THERE IS NO WARRANTY FOR THE PROGRAM, TO THE EXTENT PERMITTED BY APPLICABLE LAW. EXCEPT WHEN OTHERWISE STATED IN WRITING THE COPYRIGHT HOLDERS AND/OR

OTHER PARTIES PROVIDE THE PROGRAM "AS IS" WITHOUT WARRANTY OF ANY KIND, EITHER EXPRESSED OR IMPLIED, INCLUDING, BUT NOT LIMITED TO, THE IMPLIED WARRANTIES OF MERCHANTABILITY AND FITNESS FOR A PARTICULAR PURPOSE. THE ENTIRE RISK AS TO THE QUALITY AND PERFORMANCE OF THE PROGRAM IS WITH YOU. SHOULD THE PROGRAM PROVE DEFECTIVE, YOU ASSUME THE COST OF ALL NECESSARY SERVICING, REPAIR OR CORRECTION.

12. IN NO EVENT UNLESS REQUIRED BY APPLICABLE LAW OR AGREED TO IN WRITING WILL ANY COPYRIGHT HOLDER, OR ANY OTHER PARTY WHO MAY MODIFY AND/OR REDISTRIBUTE THE PROGRAM AS PERMITTED ABOVE, BE LIABLE TO YOU FOR DAMAGES, INCLUDING ANY GENERAL, SPECIAL, INCIDENTAL OR CONSEQUENTIAL DAMAGES ARISING OUT OF THE USE OR INABILITY TO USE THE PROGRAM (INCLUDING BUT NOT LIMITED TO LOSS OF DATA OR DATA BEING RENDERED INACCURATE OR LOSSES SUSTAINED BY YOU OR THIRD PARTIES OR A FAILURE OF THE PROGRAM TO OPERATE WITH ANY OTHER PROGRAMS), EVEN IF SUCH HOLDER OR OTHER PARTY HAS BEEN ADVISED OF THE POSSIBILITY OF SUCH DAMAGES.

END OF TERMS AND CONDITIONS

How to Apply These Terms to Your New Programs

If you develop a new program, and you want it to be of the greatest possible use to the public, the best way to achieve this is to make it free software which everyone can redistribute and change under these terms.

To do so, attach the following notices to the program. It is safest to attach them to the start of each source file to most effectively convey the exclusion of warranty; and each file should have at least the "copyright" line and a pointer to where the full notice is found.

<one line to give the program's name and a brief idea of what it does.>
Copyright (C) <year> <name of author>

This program is free software; you can redistribute it and/or modify it under the terms of the GNU General Public License as published by the Free Software Foundation; either version 2 of the License, or (at your option) any later version.

This program is distributed in the hope that it will be useful, but WITHOUT ANY WARRANTY; without even the implied warranty of MERCHANTABILITY or FITNESS FOR A PARTICULAR PURPOSE. See the GNU General Public License for more details.

You should have received a copy of the GNU General Public License along with this program; if not, write to the Free Software Foundation, Inc., 51 Franklin Street, Fifth Floor, Boston, MA 02110-1301 USA.

Also add information on how to contact you by electronic and paper mail.

If the program is interactive, make it output a short notice like this when it starts in an interactive mode:

Gnomovision version 69, Copyright (C) year name of author Gnomovision comes with ABSOLUTELY NO WARRANTY; for details type `show w'. This is free software, and you are welcome to redistribute it under certain conditions; type `show c' for details.

The hypothetical commands `show w' and `show c' should show the appropriate parts of the General Public License. Of course, the commands you use may be called something other than `show w' and `show c'; they could even be mouse-clicks or menu items--whatever suits your program.

You should also get your employer (if you work as a programmer) or your school, if any, to sign a "copyright disclaimer" for the program, if necessary. Here is a sample; alter the names:

Yoyodyne, Inc., hereby disclaims all copyright interest in the program
`Gnomovision' (which makes passes at compilers) written by James Hacker.

<signature of Ty Coon>, 1 April 1989

Ty Coon, President of Vice

This General Public License does not permit incorporating your program into proprietary programs. If your program is a subroutine library, you may consider it more useful to permit linking proprietary applications with the library. If this is what you want to do, use the GNU Lesser General Public License instead of this License.