

AC Power Meter

GPM-8212

USER MANUAL

GW INSTRUMENT PART NO. 82PM-82120MB



ISO-9001 CERTIFIED MANUFACTURER **GW INSTRUMENT**

This manual contains proprietary information, which is protected by copyrights. All rights are reserved. No part of this manual may be photocopied, reproduced or translated to another language without prior written consent of Good Will company.

The information in this manual was correct at the time of printing. However, Good Will continues to improve products and reserves the rights to change specification, equipment, and maintenance procedures at any time without notice.

Good Will Instrument Co., Ltd.

No. 7-1, Jhongsing Rd., Tucheng City, Taipei County 236, Taiwan.

TABLE OF CONTENTS

PAGE

1. SAFETY SUMMARY.....	1
2. INTRODUCTION.....	5
3. SPECIFICATION.....	6
4. PANEL INTRODUCTION & WIRING.....	8
5. USAGE DESCRIPTION.....	16
6. RS232 COMMUNICATION INTERFACE.....	18
7. MAINTENANCE.....	21

1.SAFETY TERMS AND SYMBOLS

Please take a moment to review these safety terms and symbols which may appear in this manual or on Equipment to prevent damage to the Power Meter.



WARNING. Warning statements identify condition or practices that could result in injury or loss of life.



CAUTION. Caution statements identify conditions or practices that could result in damage to this product or other property.



DANGER High Voltage



ATTENTION refer to Manual



Protective Conductor Terminal



(ground) Earth Terminal



Frame or Chassis Terminal

FOR UNITED KINGDOM ONLY

NOTE: This lead/appliance must only be wired by competent persons

WARNING: THIS APPLIANCE MUST BE EARTHED

IMPORTANT: The wires in this lead are coloured in accordance with the following code:

Green/ Yellow: Earth
Blue: Neutral
Brown: Live(Phase)

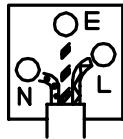

As the colours of the wires in main leads may not correspond with the colours marking identified in your plug/appliance, proceed as follows:

The wire which is coloured Green & Yellow must be connected to the Earth terminal marked with the letter E or by the earth symbol

 or coloured Green or Green & Yellow.

The wire which is coloured Blue must be connected to the terminal which is marked with the letter N or coloured Blue or

Black.

The wire which is coloured Brown must be connected to the terminal marked with the letter L or P or coloured Brown or Red.

If in doubt, consult the instructions provided with the equipment or contact the supplier.

This cable/appliance should be protected by a suitably rated and approved HBC mains fuse : refer to the rating information on the equipment and/or user instructions for details. As a guide, cable of 0.75mm² should be protected by a 3A or 5A fuse. Larger conductors would normally require 13A types, depending on the connection method used.

Any moulded mains connector that requires removal /replacement must be destroyed by removal of any fuse & fuse carrier and disposed of immediately, as a plug with bared wires is hazardous if a engaged in live socket. Any re-wiring must be carried out in accordance with the information detailed on this label.

2. INTRODUCTION

GPM-8212 Power Meter is a 16-bit CPU microprocessor equipped with multifunction of full-digitized measurement, calibration and output. The microprocessor has the advantage of high-speed sampling and calculation function to accurately measure the distortion signal of waveform. Except for its essential measurement on AC voltage, AC current, AC power, Power factor, and Frequency, the power meter also provides additional features of PT/CT ratio setting, display value holding, the value of maximum and minimum holding, range selecting, auto-ranging and etc.

In order for an even more efficient and convenient communication, the standard RS232 or RS485 is available as an option attached to the instrument.

The GPM-8212 is a low-cost, easy-to-use power measuring instrument.

3. SPECIFICATION

VOLTAGE								
Range	5.000V, 10.00V, 20.00V, 40.00V, 80.00V, 160.0V, 320.0V, 640.0V total 8 ranges by auto-range or manual.							
Measurement Type	True rms							
Input Resistance	$\geq 1M$							
Maximum Input Voltage	1000V(peak), 700V(rms)							
PT Ratio Setting	1 to 9999							
Accuracy (at 23°C $\pm 5^\circ\text{C}$) (Sinewave)	$\pm 0.1\%$ of reading $\pm 0.1\%$ of range							
CURRENT								
Range	160.0mA, 320.0mA, 640.0mA, 1.280A, 2.560A, 5.120A, 10.24A, 20.48A total 8 ranges by auto-range or manual.							
Measurement Type	True rms							
Input Resistance	0.01							
Maximum Input Current	30A (peak), 20A (rms)							
CT Ratio setting	1 to 9999							
Accuracy(at 23°C $\pm 5^\circ\text{C}$) (Sinewave)	$\pm 0.1\%$ of reading $\pm 0.1\%$ of range							
WATT								
Range:								
W \ A	160.0mA	320.0mA	640.0mA	1.280A	2.560A	5.120A	10.24A	20.48A
V	5.000V	10.00V	20.00V	40.00V	80.00V	160.0V	320.0V	640.0V
	800.0mW	1.600W	3.200W	6.400W	12.80W	25.60W	51.20W	102.4W
	1.600W	3.200W	6.400W	12.80W	25.60W	51.20W	102.4W	204.8W
	3.200W	6.400W	12.80W	25.60W	51.20W	102.4W	204.8W	409.6W
	6.400W	12.80W	25.60W	51.20W	102.4W	204.8W	409.6W	819.2W
	12.80W	25.60W	51.20W	102.4W	204.8W	409.6W	819.2W	1.638kW
	25.60W	51.20W	102.4W	204.8W	409.6W	819.2W	1.638kW	3.276kW
	51.20W	102.4W	204.8W	409.6W	819.2W	1.638kW	3.276kW	6.553kW
	102.4W	204.8W	409.6W	819.2W	1.638kW	3.276kW	6.553kW	13.10kW
Measurement Type	True rms							
Accuracy(at 23°C $\pm 5^\circ\text{C}$) (Sinewave)	$\pm 0.2\%$ of reading $\pm 0.2\%$ of range							

POWER FACTOR	
Range	0.001 to 1.000
Computation	$W \div (V \times A) = \text{Power factor (PF)}$
FREQUENCY	
Measurement Range	40.0Hz to 400.0Hz
Accuracy (23°C ±5°C)	±0.2% of reading ±2 digits
OPTION	
Communication	RS-232, RS-485
GENERAL	
Main Supply	AC86~265V, 50/60Hz
Warm up time	30 minutes more.
Display	A 4-digit 0.56" LED with 2 sets of 4-digit 0.4" LED.
Minimum input	2% of Range
Response time	2 cycles/sec
Overload indicating	"O.L"
Working temperature	0~50°C, RH < 80%
Temperature coefficient	±0.1% FS/°C
Accessories	Instruction manual × 1, Power cord × 1, Disk × 1
Dimension	250(W)×90(H)×281(D) m/m
Weigh	Approx. 1.6 kgs

Note: The 1.0mm² of cross-section dimension power cord should be used when the current reaches to 10 Amperes, and use 2.0mm² of cross-section dimension power cord when the current reaches to 20 Amperes.

4. PANEL AND OUTLOOK INTRODUCTION

- Fig 4.1 FRONT PANEL

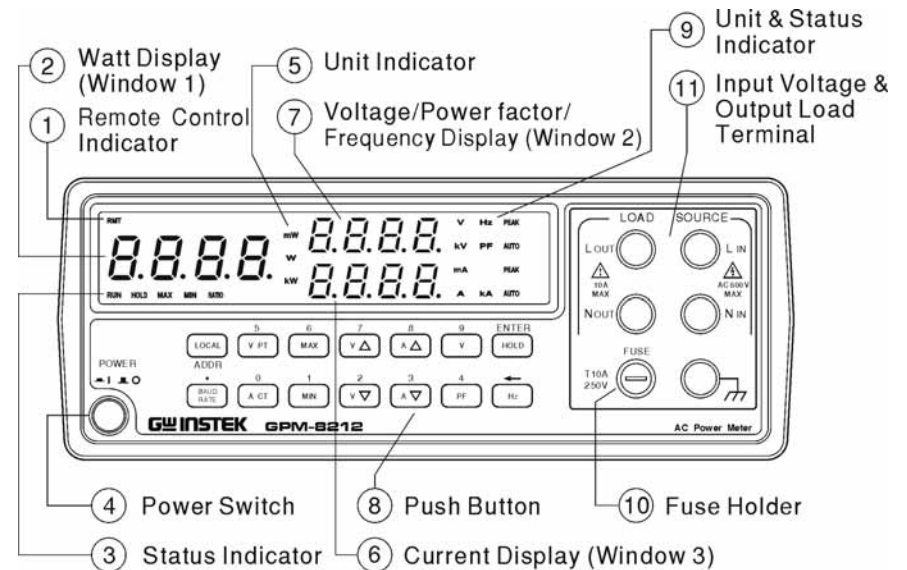

4-1.Function Description

(1) Remote Control Indicator

RMT Remote Control Indicator

(3) Status Indicator

RUN When the instrument is working normal, the RUN indicator is flashing stably, if not, it will be appeared constant on or off.

HOLD The HOLD indicator is on when press the key of HOLD to maintain the display value not to be changed by any input.

MAX The MAX indicator is on when press the key of MAX, the display then appears the maximum value it obtained.

MIN The MIN indicator is on when press the key of MIN, the display then appears the minimum value it obtained.

RATIO The indicator is on when the value of PT and CT is set to other value except 1.

(5) Unit Indicator

mW Display Window 【1】 Milliwatt indicator.

W Display Window 【1】 Watt indicator.

kW Display Window 【1】 Kilowatt indicator.

(9) Unit & Status Indicator

V Display Window 【2】 Volt indicator.

kV Display Window 【2】 Kilovolt indicator.

PF Display Window 【2】 Power Factor indicator.

Hz Display Window 【2】 Hertz indicator.

mA Display Window 【3】 Milliampere indicator.

A Display Window 【3】 Ampere indicator.



Display Window 【3】 Kiloampere indicator.

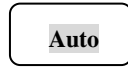

Display Window 【2】 Auto-range indicator. The indicator is on when the window of voltage measurement is set to auto-range. The voltage measurement will be auto-ranged following the change of external voltage.

Display Window 【3】 Auto-range indicator. The indicator is on when the window of current measurement is set to auto-range. The current measurement will be auto-ranged following the change of external current.

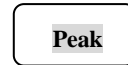

Window 【2】 for voltage Peak indicator. The Vpeak indicator is on when the input voltage peak is larger than the measurement of voltage range.

***If the Vpeak indicator is illustrated with manual ranging, switch range by using ΔV button.**

Window 【3】 for current Peak indicator. The Apeak indicator is on when the input current peak is larger than the measurement of current range.

***If the Apeak indicator is illustrated with manual ranging, switch range by using ΔA button.**

(8) Pushbuttons



Set up address for RS-458 interface only.

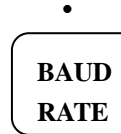

Number key.

Set interface baudrate with 1200, 2400, 4800 and 9600 bps available for selection.

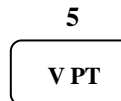

Number key.

Set PT Ratio range at 1~9999.

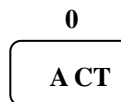

Number key.

Set CT Ratio range at 1~9999.



Number key.

Set to the maximum value of the display, then press the button again back to previous status.

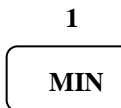

Number key.

Set to the minimum value of the display, then press the button again back to previous status.

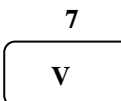

Number key.

Set the voltage range upward, press and hold the button for 2 seconds to enter autorange of voltage.

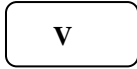
2*Number key.*

Set the voltage range downward, press and hold the button for 2 seconds to enter autorange of voltage.

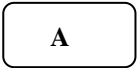
8*Number key.*

Set the current range upward, press and hold the button for 2 seconds to enter autorange of voltage.

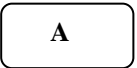
3*Number key.*

Set the current range downward, press and hold the button for 2 seconds to enter autorange of current.

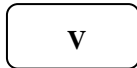
9*Number key.*

Set Window **【2】** to indicate Voltage function.

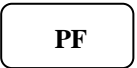
4*Number key.*

Set Window **【2】** to indicate power factor function.

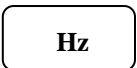
*Back key.*

Set Window **【2】** to indicate frequency function.

ENTER*Enter key.*

Maintain the present display value.

● **Fig. 4-2 REAR PANEL**

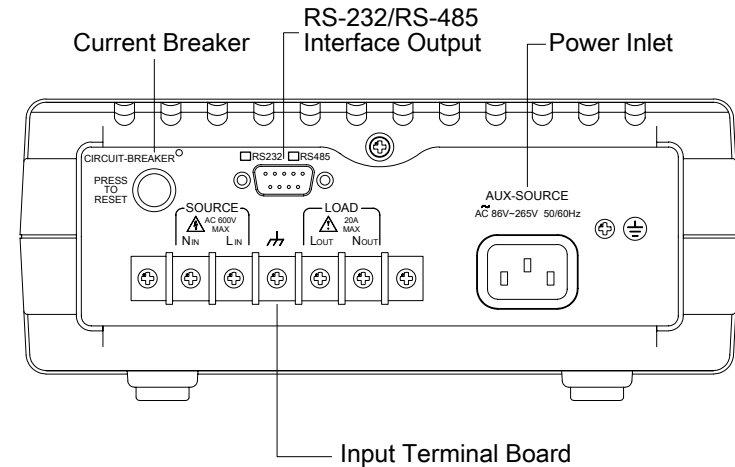

****Current Breaker: This is an Over-current protected component. When the measurement is interrupted with over current input, please reduce the measured load, then re-switch on, the measurement can be back to normal.**

4-2. Wiring

- Without PT or CT:

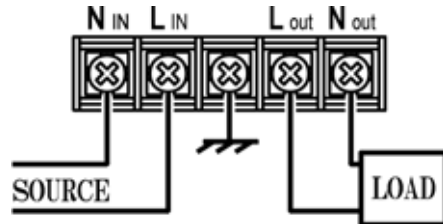

- With CT

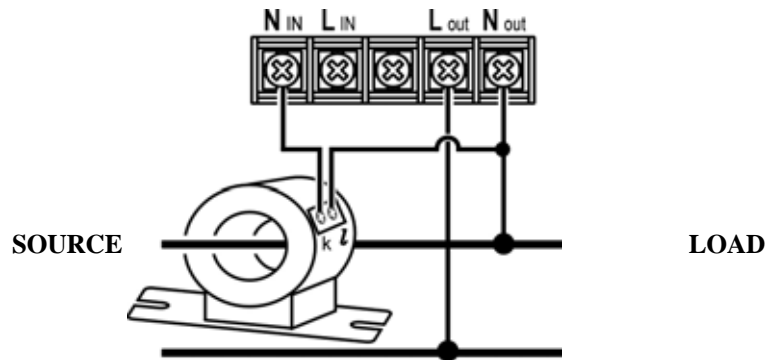

WARNING: Make sure that the source power is off before any wiring connection.



WARNING: Make sure that all connectors are well connected before the source power is on.

5. USAGE DESCRIPTION

- Baudrate setting

- 1) Press the button of Baud to appear the letter of BAUD on the window 2, window 3 indicates the previous setting parameters, and window 1 appears "-----". If no further action, it will return to previous test mode within 5 seconds, or press [Back] button directly.
- 2) Then proceed the following steps to set the desired parameters, such as 1200:
 - Press [1] to appear 1---
 - Press [2] to appear 12--.
 - Press [0] to appear 120-.
 - Press [0] to appear 1200.
- 3) If there is any mistake, press [←] key to erase front error numbers.
- 4) After pressing [ENTER] to save the information, return to test mode.

- Address setting

- 1) Press [Addr] to appear ADDR on the window 2, window 3 indicates previous setting parameters and window 1 appears "——". If no further action, it will return to previous test mode within 5 seconds, or press [Back] button directly.
- 2) Then proceed the following steps to set the desired parameters, such as 10:
 - Press [1] to appear 1-.
 - Press [0] to appear 10.
- 3) If there is any mistake, press [←] key to erase front error numbers.
- 4) After pressing [ENTER] to save the information, return to test mode.

- **PT Ratio setting**

- 1) Press the button of [VPT] to appear the letters of PT on the window 2, window 3 indicates the previous setting parameter, and window 1 appears "-----". If no further action, it will return to previous test mode within 5 seconds, or press [←] key directly.
- 2) Then proceed the following steps to set the desired parameters, such as 1000:
 - Press [1] to appear 1---
 - Press [0] to appear 10--.
 - Press [0] to appear 100-.
 - Press [0] to appear 1000.
- 3) If there is any mistake, press [←] key to erase front error numbers.
- 4) After pressing [ENTER] to save the information, return to test mode.

- **CT Ratio setting**

- 1) Press the button of [ACT] to appear the letters of CT on the window 2, window 3 indicates the previous setting parameters, and window 1 appears "-----". If no further action, it will return to previous test mode within 5 seconds, or press [←] key directly.
- 2) Then proceed the following steps to set the desired parameters, such as 1000:
 - Press [1] to appear 1---
 - Press [0] to appear 10--.
 - Press [0] to appear 100-.
 - Press [0] to appear 1000.
- 3) If there is any mistake, press [←] key to erase front error numbers.
- 4) After pressing [ENTER] to save the information, return to test mode

6. RS232 COMMUNICATION INTERFACE

- **Introduction**

The instrument can be operated from a host (eg. A terminal controller, computer, PLC...) by sending commands through a computer interface on the rear panel.

- **Communication parameter**

Baudrate : 1200, 2400, 4800, 9600 bps.

Parity : None

Data bits : 8

Stop bit : 1

- **Wire drawing : Located in the rear panel of GPM-8212.**

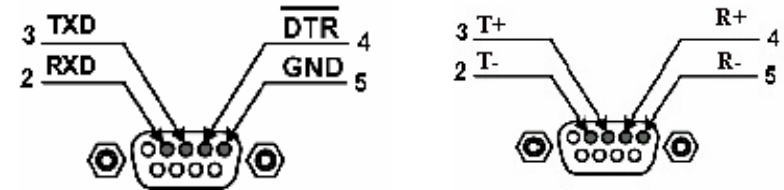

RS-232

RS-485

Pin 232:

SIGNAL	$\overline{\text{CD}}$	RXD	TXD	$\overline{\text{DTR}}$	GND	$\overline{\text{DSR}}$	$\overline{\text{RTS}}$	$\overline{\text{CTS}}$	RI
9 PIN	1	2	3	4	5	6	7	8	9
25PIN	8	3	2	20	7	6	4	5	22

Pin 485:

SIGNAL	NC	TxD	TxD	RxD	RxD	NC	NC	NC	NC
		-	+	+	-				
PIN No.	1	2	3	4	5	6	7	8	9

- **Communication command**

COMMAND	DESCRIPTION	EXAMPLE
F00	Data hold enable	
F01	Data hold disable	
F02	Set in maximum status	
F03	Set in minimum status	
F04	Set in normal status	
R00	V Range=640.0V	
R01	V Range=320.0V	
R02	V Range=160.0V	
R03	V Range=80.00V	
R04	V Range=40.00V	
R05	V Range=20.00V	
R06	V Range=10.00V	
R07	V Range=5.000V	
R08	A Range=20.48A	
R09	A Range=10.24A	
R10	A Range=5.120A	
R11	A Range=2.560A	
R12	A Range=1.280A	
R13	A Range=640.0mA	
R14	A Range=320.0mA	
R15	A Range=160.0mA	
R16	V Range=Autorange	
R17	A Range=Autorange	
S00	Set Voltage Ratio(PT)	S00:1
S01	Set Current Ratio(CT)	S01:1
V00	Read Voltage	
V01	Read Current	
V02	Read Watt	
V03	Read PF	
V04	Read Hz	

- **DEMO Program**

; Demo program language: BASIC
 ; Computer set Baudrate equal 9600, and use COM2
 ; The GPM-8212 set Baudrate equal 9600
 ; Command define in CMD\$

```
10CMD$= "V00"
20VALUE$= " "
30OPEN "COM2:9600,N,8,,CS,DS,CD" FOR RANDOM AS#2 LEN=1
40FOR I= 1 TO 100
50PRINT #2, CMD$
60INPUT #2, VALUE$
70PRINT VALUE$
80NEXT I
90CLOSE #2
100END
```

7. MAINTENANCE

The following instructions are used by qualified person only to avoid electrical shock, do not perform any service other than contained in the operation instructions unless you are qualified to do so.

7-1.Fuse Rating and type

If the fuse is ruptured, the Power METER will not operate. Try to determine and correct the cause of the blown fuse, then replace the fuse with correct rating and type shown as below:

MODEL	FUSE Rating and Type	Rating Input	
		Watts	VA
GPM-8212	115V/230V T0.5A 250V	22	28



WARNING: For continued fire protection, replace only with 250V fuse of the specified type and rating, and disconnect the power cord before proceeding fuse replacement.

7-2.Fuse Replacement Procedure

When you proceed calibration or maintenance of the Power Meter, if you want to replace the fuse, the upper cover must be removed according to the following steps:

- 1).The handle must be turned downward 90 degrees first.

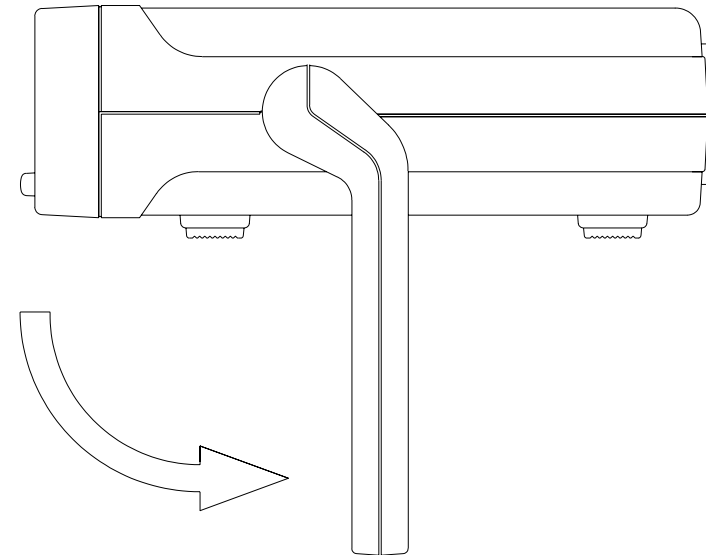

- 2). Pull apart the handle from the Power Meter. Please turn the handle left and right side slightly, that will make it easier to pull off the handle.

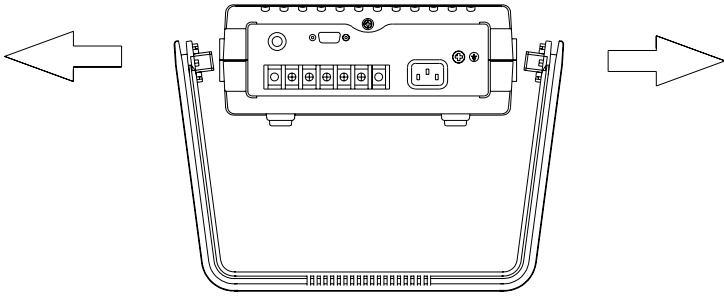

- 3). There are two washers inside of two holes (the joints of handle and case) respectively. Please use a screwdriver to pry open these washers.

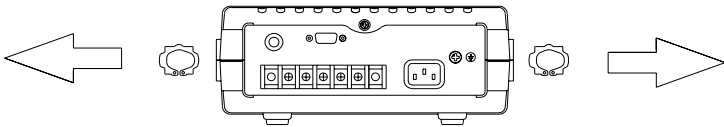

- 4). Please use a screwdriver to open the screw located at upper side of rear panel. Therefore, the upper cover can pull toward the backside. In the meantime, the upper cover is moved.

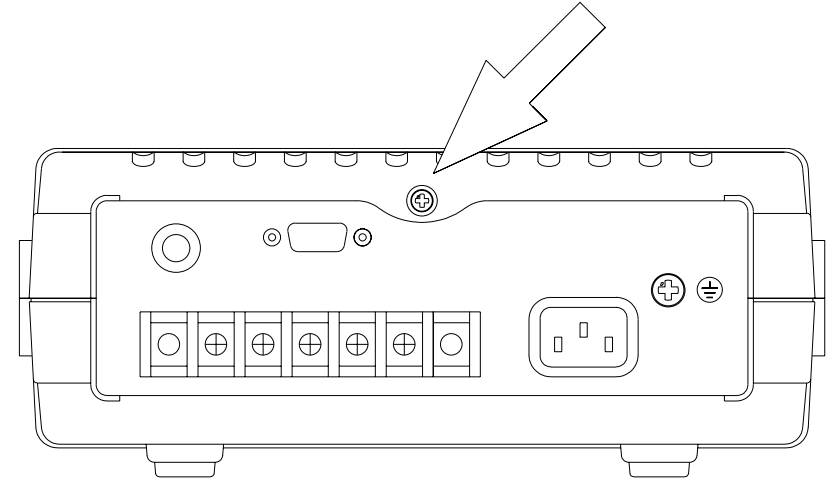

Note: If you want to install the upper cover, please reverse above steps.

7-3. Cleaning

To keep the instrument clean, wipe the case with a damp cloth and detergent. Do not use abrasives or solvents.